

INSTALLATION/OPERATION

DET-1600 DETONATION SENSING MONITOR

FORM DET-1600 IOM 11-09

**WARNING:**

DEVIATION FROM THIS INSTALLATION/OPERATING MANUAL MAY LEAD TO IMPROPER OPERATION OF THE MONITORED MACHINE WHICH COULD CAUSE PERSONAL INJURY TO OPERATORS OR OTHER NEARBY PERSONNEL.

**CAUTION:**

THE DET-1600 DETONATION SENSING MONITOR IS CERTIFIED FOR USE IN CLASS I, GROUPS C & D, DIVISION 2 HAZARDOUS LOCATIONS WHEN INSTALLED IN ACCORDANCE WITH THESE INSTRUCTIONS.

THE SENSOR INPUT LEADS CONNECTED TO THIS DEVICE OPERATE AT A LOW VOLTAGE AND POWER LEVEL AND MUST NOT CONTACT ANY EXTERNAL VOLTAGE SOURCE. DAMAGE TO THE SYSTEM WILL RESULT FROM CONNECTION BETWEEN THE INPUT SENSOR LEADS AND THE IGNITION SYSTEM OR ANY AC OR DC POWER SOURCE ABOVE 36 VDC.

1.0 DESCRIPTION

1.1 The Altronic **DET-1600 Detonation Sensing Monitor** is a **32-bit** microprocessor-based electronic instrument designed to detect and eliminate detonation on natural gas-fueled engines before damage occurs. Industry-standard low cost broadband piezoelectric vibration sensors, mounted on the engine, are used to transform the vibrations caused by detonation into electrical signals which are then evaluated by the **DET-1600**. The **Detonation Sensing Monitor** uses the sensors to measure the combustion intensity of each cylinder in a user-configured time window. The detonation signals are filtered by programmable filters and then sent to the microprocessor for further processing and evaluation. This process is repeated for every cylinder on a cycle-by-cycle basis. The resulting two reference numbers, one for detonation intensity and the other for the lack of a combustion process, or misfire, are displayed on a LCD display. These reference numbers are used to control two output switches, typically one for load control and the other for shutdown, and a **4-20mA** current loop or **Modbus RTU** output used to retard ignition timing.

The **2 x 16** backlit LCD is used to display the detonation and misfire reference level numbers, engine cylinder labels, control and output switch status, the cause of shutdown log, as well as diagnostic messages. The reference numbers are compared to adjustable setpoint values. These setpoint values are user adjustable and when exceeded by the reference numbers signal the output switches to trip. The switches can be used to control load, ignition timing, and/or to shut down the engine. The **4-20mA** current loop output is fully configurable and can be used to adjust ignition timing or engine load. The **RS485 Modbus RTU** output can be used for timing adjustment.

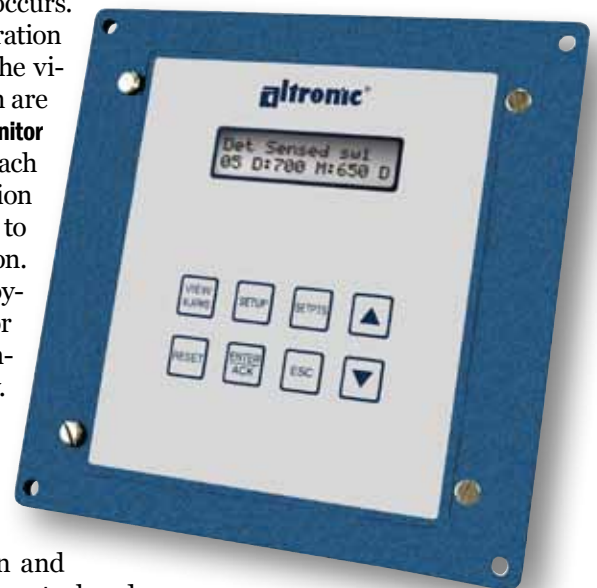

DET-1600 DETONATION SENSING MONITOR

1.2 The **DET-1600** is housed in a **6.5" x 6.5"** rugged powder-coated aluminum case. The user interface is an 8-key membrane keypad along with a **2 x 16** backlit LCD. The monitor accepts up to **16** detonation sensors that are wired to pluggable Phoenix-type connectors. The **DET-1600** can be set up for one sensor per cylinder, one per two cylinders, or one per bank.

1.3 POWER REQUIREMENT

The power requirement is **10 to 32Vdc, 0.30Amp** max.

1.4 The **DET-1600** is configured (user customized) for each engine application using the **TERMINAL PROGRAM** on a PC or laptop computer. For similar setups, configurations can be saved to the PC and recalled at a later time. A library of applications can be created saving time and effort for similar applications.

NOTE: If possible, keep the original shipping container. If future transportation or storage of the monitor is necessary, this container will provide the optimum protection.



WARNING: THE DET-1600 Detonation Sensing Monitor **MUST BE CONFIGURED PRIOR TO USE ON AN ENGINE. REFER TO SECTION 6.0, CONFIGURING THE DET-1600.**

2.0 DETONATION/VIBRATION SENSORS

2.1 The detonation (or knock) sensors convert the engine vibrations to an electrical signal that is proportional to acceleration. These signals are then used by the **DET-1600** to measure the amplitude and frequency of the detonation. The sensors are of the low cost automotive broadband piezoelectric type. In order to use these signals properly, the sensors must be securely bolted to the engine block at their optimum locations (see mounting section below and **FIGURES 3, 4, AND 5** for further sensor application information). The detonation/vibration sensor suggested for use with the **DET-1600 Detonation Sensing Monitor** is the **Bosch P/N 0 261 231 148**. Equivalent models from other manufacturers may also be used. The Bosch sensor is available from Altronic as **P/N 615107**. The cable assembly is **P/N 693134-x**.

Description	Part Number
Vibration Sensor	615107
Cable Assembly, 10'	693134-1
Cable Assembly, 20'	693134-2
Cable Assembly, 30'	693134-3
Cable Assembly, 40'	693134-4
Cable Assembly, 50'	693134-5
Cable Assembly, 100'	693134-6

NOTE: Avoid mounting the Monitor with the LCD display facing direct sunlight. The display temperature range is -22°F to +175°F (-30°C to +80°C).

3.0 MOUNTING

3.1 DETONATION SENSING MONITOR (SEE FIGURE 1)

Mount the **DET-1600** inside a control panel or to a suitable flat surface so that the display is at a convenient viewing height. A drilling template is provided.

3.2 DETONATION SENSORS (SEE FIGURE 4)

The number, location, and mounting procedure of the detonation sensors are dependent on the engine type and number of sensors used for the system. One sensor per cylinder is required for misfire detection.

3.2.1 LOCATION

The sensors should be as symmetrically distributed between the cylinders as possible and positioned in the center of each cylinder on the engine crankcase just below the cylinder heads. If possible, refrain from mounting sensors to the cylinder head as valve gear noise may interfere with the sensor signal. The mechanical noise level may prevent proper operation of misfire detection if sensors are mounted on the head bolts. The sensors should be mounted at locations where exposure to liquids such as gasoline, antifreeze, oil, brake fluid, etc is minimal. Angular mounting position is arbitrary.

3.2.2 MOUNTING PROCEDURE

Mount the detonation sensors to a smooth surface on the engine crankcase. A surface that is not smooth will give erratic readings. Drill and tap the block perpendicular to the surface, counterbore if necessary, and take care not to penetrate the water jacket. Use a bolt of **M8x25, grade 8.8**. Make sure the bolt does not bottom-out in the tapped hole. Torque the bolt to **20 ± 5Nm (15 ± 1FtLb)**. Do not over-tighten, damage may occur to the sensor. No washer of any kind is permissible. Only the metallic part of the sensor (φ 22mm) may make contact with the engine.

DET-1600 DETONATION SENSING MONITOR

4.0 WIRING (SEE WIRING DIAGRAMS)

4.1 GENERAL

The **DET-1600** is designed to work with negative ground C.D. ignition systems with a nominal primary voltage of **100 to 250** volts peak. The **DET-1600** uses the Ignition System's shutdown lead as well as the **#1** cylinder's primary lead as input signals. Each cylinder firing must be available for proper operation.

In addition the following guidelines must be adhered to:

1. **The engine ignition system must be a negative ground C.D. ignition system with a nominal primary voltage of 100 to 250 volts peak.**
2. **The ignition shutdown lead signal must provide one firing for each cylinder. Consult factory for applications with dual capacitor ignition systems with only half of the cylinder signals available on the shutdown lead.**
3. **For the minority of engines with non-repeating odd firing patterns or engines that fire two cylinders at a time, consult the factory for installation procedures.**

Take care not to damage the insulation and take precautions against damage from vibration, abrasion or liquids in conduits. Also never run sensor, low voltage power, current loop, communications, or output switch wires in the same conduit as the ignition wiring or other high energy wiring such as AC line power, etc. Keep wires at least 12 inches away from all high voltage wiring.

Keep secondary wires to spark plugs and other high voltage wiring at least 8 inches (200mm) away from detonation sensors and their wiring.

4.2 POWER WIRING

Connect the power input wires to terminals (DC+) and (DC-); power requirement is 10 to **32Vdc, 0.30Amp max.** Connect the minus terminal (DC-) to panel ground, which must be the same as engine ground. **DO NOT CONNECT THE MINUS TERMINAL DIRECTLY TO THE IGNITION SYSTEM COMMON COIL GROUND ON THE ENGINE.**

4.3 SHUTDOWN LEAD INPUT

The shutdown lead of an ignition system is used to sense rotation and for determining the timing degree window position. Connect a wire from the shutdown lead of a negative ground C.D. ignition system to the back of the **DET-1600** monitor to the terminal marked **SD LEAD**. The ground connection will be made through the DC- terminal on the back of the monitor that is connected to panel ground which should be the same as engine ground.

4.4 NUMBER 1 CYLINDER IGNITION COIL PRIMARY OF A C.D. IGNITION SYSTEM

The number **1** cylinder signal is used to sense rotation, calculate rpm and for an angular reference point. Connect a wire from the number 1 cylinder ignition coil primary of a negative ground C.D. ignition system to the back of the **DET-1600** monitor to the terminal marked **#1 COIL INPUT**. The ground connection will be made through the DC- terminal on the back of the monitor that is connected to panel ground which should be the same as engine ground.

NOTE: Altronic HIGHLY RECOMMENDS the use of resistor spark plugs and/or spark plug leads with all digital instrumentation as a means of reducing the impact of RFI (radio frequency interference) on operation.

NOTE: The ignition shutdown lead must provide one firing for each cylinder.

4.5 DETONATION SENSOR WIRING

The detonation sensors generate low voltage bipolar signals of approximately **26mV/g**. Mount the sensors as described above. Each detonation sensor requires two wires. Use a two conductor cable of **20-22AWG** (Altronic **693134-x** or equivalent) to wire the detonation sensor to the sensor input terminals on the back of the **DET-1600**. The sensor cables should be run in rigid conduit or Sealtite/Liquidtite to protect the wires from breakage. Wire the detonation sensors in the firing order of the engine. Use the sensor wiring chart **FIGURE 5** as a wiring aid.

Wiring examples of sensors:

Example 1 **One sensor per cylinder on 6 cylinder inline engine**

Firing order: **1-5-3-6-2-4**

Sensor configuration: **Sensor #1 for cylinder #1**
 Sensor #5 for cylinder #5
 Sensor #3 for cylinder #3
 Sensor #6 for cylinder #6
 Sensor #2 for cylinder #2
 Sensor #4 for cylinder #4

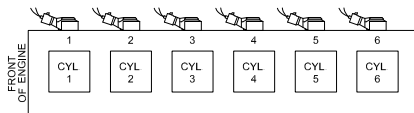

Terminal # on back of DET-1600	1	2	3	4	5	6
Cylinder # (as marked on engine)	1	5	3	6	2	4
Sensor #	1	5	3	6	2	4

Example 2 **One sensor per cylinder on a 12 cylinder "V" engine.**

Firing order: **1R-6L-5R-2L-3R-4L-6R-1L-2R-5L-4R-3L**

Sensor configuration: **Sensor #1 for cylinder 1R**
 Sensor #12 for cylinder 6L
 Sensor #5 for cylinder 5R
 ...
 Sensor #9 for cylinder 3L

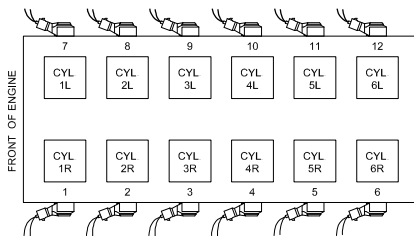

Terminal # on back of DET-1600	1	2	3	4	5	6	7	8	9	10	11	12
Cylinder # (as marked on engine)	1R	6L	5R	2L	3R	4L	6R	1L	2R	5L	4R	3L
Sensor #	1	12	5	8	3	10	6	7	2	11	4	9

DET-1600 DETONATION SENSING MONITOR

4.6 OUTPUT SWITCH WIRING

Exceeding a setpoint value will cause the user programmable output switch to turn **ON/OFF** with respect to its common. The **DET-1600** contains two output switches. Switch **1** is typically used to initiate load control and switch **2** is typically used to initiate a shutdown sequence. Output switch **1** will trip when an input value exceeds either the misfire setpoint value (a low setpoint) or the detonation setpoint value (a high setpoint). Output switch **2** will trip when the max retard value has been reached and the switch **2** timer has expired. These switches are solid state, form C (N/O and N/C) break-before-make contacts and are isolated from the power supply. Switch **1** is closed with the absence of power and switch **2** is open with the absence of power. The switches are rated at **200V, 200mA** and the N/O switch has a unique internal overload current protection circuit. If an overload occurs, the internal circuitry limits current to safe levels. When the overload is removed, the relay resumes its normal **ON** characteristics. These switches can be wired to engine management systems, an Altronic annunciator system or to pilot duty relays as shown by the wiring diagrams.

4.7 OUTPUT CURRENT LOOP WIRING

The **DET-1600** has a **4-20mA** current loop output available. This output can be used to retard ignition timing, control loads, or adjust system valves, actuators, and other devices commonly used in process control. The current loop output is labeled **4-20mA OUT** and is internally limited to **25mA**. The output is protected against open and short circuits. A **250 ohm** receiving resistor can be used over the entire supply voltage range from **10 to 32Vdc**. The maximum load resistance that can be tolerated in the loop is determined by the supply voltage. When using the maximum rated loop resistor of **500 ohms** with a desired full scale loop output of **20mA**, the supply voltage must be between **15** and **32Vdc**. At **12Vdc** supply voltage, the maximum load resistor for 20 mA loop output current is **350 ohms**. **REFER TO THE WIRING DIAGRAMS** for typical hook-up.

4.8 RS-485 COMMUNICATIONS WIRING

The **DET-1600** has two **RS485 Modbus RTU** communications links, one is a master the other a slave. The **Modbus** slave port is used to transfer data to and from a PC or laptop to configure and monitor the **DET-1600**. The **Modbus** master port is used to transfer timing data instructions to an ignition system to perform ignition timing control. Wire the **Modbus** slave terminals to a PC or laptop computer to configure and monitor the **DET-1600**. If the installation requires ignition control via Modbus, wire the **Modbus** master to a **Modbus RTU-enabled** ignition system. Use a two-conductor shielded cable of fine gauge stranded wire and connect the wires to the terminals marked **RS485 A** and **RS485 B**. Make the following connections to the other communication device **A** to **A(-)** and **B** to **B(+)**. If required, connect the shield wire to the master device only.

4.9 HAZARDOUS AREA OPERATION

The **DET-1600** Detonation Monitor is **CSA certified** for **CLASS I, DIVISION 2, GROUPS C & D** areas. The **DET-1600** is certified as a component only and is required to be installed in a suitable enclosure where the suitability of the combination is subject to the local inspection authority having jurisdiction. The power connections to the **DET-1600** must be in accordance with the **National Electrical Code** and in Canada, the **Canadian Electrical Code**. In addition, the following requirements must be met:

1. **Run the sensor wires leaving the panel in a separate conduit from all other wiring and keep them separate throughout the installation.**
2. **Power, input, and output wiring must have a grade of insulation capable of withstanding an AC voltage of 500 volts RMS.**
3. **In general, run wires in separate conduits and junction boxes from high voltage wires such as ignition, fuel valve, and other high voltage wiring.**



WARNING EXPLOSION HAZARD:

**DO NOT DISCONNECT EQUIPMENT IN DIV. 2 ENVIRONMENT
UNLESS POWER IS SWITCHED OFF OR THE AREA IS KNOWN
TO BE NON-HAZARDOUS.**

4.10 TESTING SENSOR LEADS

If it becomes necessary to check sensor to terminal wiring with an ohmmeter or other testing device, first disconnect the sensor wires from the monitor. This will prevent possible damage to the device's sensitive low voltage detection circuitry.

DET-1600 DETONATION SENSING MONITOR

5.0 THEORY OF OPERATION

5.1 DETONATION, AN OVERVIEW

A normal combustion process starts with the spark from the spark plug that occurs sometime before top dead center. This spark ignites the air fuel mixture. It burns in a steady controlled fashion across the chamber in a three dimensional fashion burning all of the fuel in the chamber for a complete burn. This causes a peak pressure to build up in the cylinder which acts upon the piston forcing it down. Peak pressure usually occurs around **16** degrees after-top-dead-center. This is the ideal or normal combustion process.

When an engine is pushed to its limits by overload, over-boost, low fuel btu, mis-tuning, and/or inadequate cooling a pinging or knocking is heard, this is called detonation. Detonation is the spontaneous combustion or the disruption of the normal controlled flame path in the combustion chamber caused by the autoignition of the end gasses in the cylinder. Detonation typically occurs after the normal combustion is initiated by the spark plug and occurs somewhere between **5°atdc** to **30°atdc**. The end gas in the combustion chamber lacks sufficient fuel rating to withstand the pressure and heat developed and causes the remaining fuel mixture to spontaneously combust. Detonation causes a pressure spike in the combustion chamber of a short duration that causes the engine to ring, or resonate like it was hit by a hammer. A small detonation is called incipient knock because it is barely audible. If the detonation is large enough, it can be heard. If detonation is allowed to continue, it can damage the engine. The **DET-1600 Detonation Monitor** is designed to guard spark-ignited gas engines from damage due to detonation.

5.2 DETONATION AND MISFIRE

The **DET-1600** system can detect both detonation and misfire. While detonation is a greater amplitude signal, misfire is the absence of a normal combustion process. The same cylinder sensor is used for both misfire and detonation detection. However, once the sensor signal enters the **DET-1600**, the signal takes separate paths, one for misfire another for detonation. The result of these processing actions is a separate misfire and detonation reference number. Both numbers are simultaneously displayed on the LCD. Separate user configuration parameters are available for misfire and detonation. The parameters are: the band-pass frequency, gain, integrator time, sampling windows, setpoint values, and display lag filter values. These parameters will typically be configured differently for misfire and detonation.

5.3 WINDOWING

The **DET-1600** uses a technique called **WINDOWING**, a user-configurable parameter which allows the device to detect detonation and misfire only during the expected time frame. Windowing is used to suppress the unwanted noises in the engine such as valves opening and closing, pistons changing direction, and also electrical noise generated each time the spark plug fires. All of these create vibrations in the same frequency range as knock. Therefore, the time for measuring knock detection has to be during expected knock periods of the engine cycle. This is called knock windowing and reduces the risk of misdetection. The window opens and closes for each individual cylinder firing. As mentioned above, detonation, when it occurs, typically occurs between **5°atdc** to **30°atdc**. In the **DET-1600**, a separate window opening and duration can be configured for detonation and misfire.

5.4 INPUT SIGNAL FILTERING

Detonation, as well as the mechanical engine noises, occurs in the audible frequency range of **20Hz** to **20kHz**. The **DET-1600** uses a configurable band-pass filter to separate the detonation vibrations from the normal engine vibrations. The theoretical detonation frequency is based on the cylinder bore diameter and the speed of sound at a typical combustion temperature and pressure. In reality, other factors also come into play such as engine mass, sensor mounting position, and the sensor design itself. Generally, a larger bore will have a lower frequency. The configurable gain is used to amplify the signal to a level that can be readily used by the system. The configurable integrator time is the resolution of the signal seen for a given time period. A shorter integrator time value will result in a larger output value because it will more closely approximate the signal. Longer integration times allow more averaging and thus will result in a smaller output value.

5.5 SEQUENCE OF OPERATION, SETPOINTS AND OUTPUTS

When the engine is running, a detonation and misfire reference level for each cylinder will be displayed on the LCD display one channel at a time. The reference numbers are a representation of the vibration intensity from the sensors. The range is **0 to 999**.

The outputs on the **DET-1600** (two switch outputs, a **4-20mA** current loop output, and/or a **Modbus RTU RS-485** output) will be enabled after the engine has reached the **Control RPM Value** and the **Control Lockout Time** has expired. Both of these parameters are configurable and allow the engine to idle, ramp up in rpm, and become stable without the outputs taking affect. Once the engine is at run speed and loaded, the reference levels from the sensors will continuously be compared against the Misfire and Detonation setpoint values.

Although the outputs of this system can be used in several different ways, the control and safety philosophy of the **DET-1600** is as follows:

NOTE: The reference numbers are related to the amplitude of the vibration signal from the sensor. On an operating engine, some variation is to be expected, especially as load, speed or ambient temperature changes.

DET-1600 DETONATION SENSING MONITOR

The first line of defense of the **DET-1600** system is typically to control load. If either a misfire or detonation occurs (the misfire reference number goes below the misfire setpoint value or the detonation reference number goes above the detonation setpoint value) output switch **#1** will activate. Switch **#1** is intended to be connected to a load control management system and to initiate load reduction of the engine. If the load reduction solves the problem (the reference numbers return to normal) no further steps are necessary, switch **#1** will deactivate. The load controller can then return the engine back to full load.

If however, despite the load reduction, detonation continues for longer than the ignition **Retard Step Timer** time, the **DET-1600** system will initiate its second line of defense and take steps to retard the ignition timing. Either the **4-20mA** loop or the **Modbus** is assumed to be tied to an external device performing timing control, which can be the ignition system itself. The timing will be retarded in the step size set by the **Retard Step Value** programmed by the user. The **Ignition Retard Step Timer** will commence. When the **Retard Step Timer expires** and if detonation is still occurring, the ignition will retard the same step size amount. This process is repeated until the initiated output action solves the problem (reference numbers return to a value below the setpoint value). With the lack of detonation, the ignition timing will remain stable for the time configured in the **Time Between Advance Steps**. Once detonation is under control, the **DET-1600** will begin removing the inserted ignition retard (advance the timing) in the amount configured in the **Advance Step Value** parameter. If detonation does not recur, the ignition timing will continue towards zero added retard in the amount configured for the **Advance Step Value**. This process will continue until the ignition timing has returned to its normal run timing value. If detonation has still not reoccurred, output switch **#1** will deactivate so that the load control system can increase the load again and the engine can resume its normal operation.

If detonation continues, and the **DET-1600** reaches the **Max Retard Timing Value Allowed**, the third line of defense will occur, switch **#2** will activate. Up until now, load has been reduced and ignition timing has been retarded to the maximum configured value. Currently, there is only one thing left to do and that is to shut down the engine to protect it from damage. Switch **#2** (if wired to do so) will **KILL** the ignition system shutting down the engine. The display will flash **View Alarms**. The shutdown status will be recorded in the status log. The status log can be viewed for the cause of the shutdown.

6.0 CONFIGURING THE DET-1600



WARNING: THE DET-1600 Detonation Sensing Monitor **MUST BE CONFIGURED PRIOR TO USE ON AN ENGINE.**

6.1 OVERVIEW

As conditions differ per engine and application (sensor mounting, different engine types, etc.) the **DET-1600 Detonation Monitor** is customized for each engine application using the **TERMINAL PROGRAM** on a PC or laptop computer. Each parameter is described below. The configuration parameter values must be carefully chosen and entered by a technician to assure proper operation of the system. The **TERMINAL PROGRAM** is included on the CDROM supplied with each **DET-1600 Monitor**. Once loaded on the PC, the connection parameters set, the **DET-1600** powered and **RS485** communication output wired to the Monitor, the current configuration can be viewed. Make the required changes to each configuration parameter; the new value will be written to the Monitor as each parameter is entered. The same terminal program is used to fine tune the parameters when on a live engine. Once the setup is complete, the parameters can be saved to a file on the PC and later recalled for similar applications.

6.2 TERMINAL PROGRAM STRUCTURE

The terminal program is designed with command menus and several folder tabs at the top of the page. Each tab is labeled with the general heading of the configuration parameters for each page. Click on each tab to select the page to be configured. Following are the descriptions of each configuration parameter.

6.3 TERMINAL PROGRAM, ESTABLISHING COMMUNICATIONS

Connect the **DET-1600** to the PC via the **RS485** port marked **RS485 MODBUS SLAVE** through a **RS485 to RS232 adapter** (for wiring details **SEE SECTION 4.8** and **FIGURE 12 (RS485 COMMUNICATIONS, PC HOOK-UP)**). Power the **DET-1600**. Load and run the terminal program. Set the **Com Port** settings to: **Com port "x"** (x is the com port used on the PC), **19200 Baud**, **1000ms Timeout**, **Parity none**, and **1 Stop Bit**. Set the **Slave ID** to **1**.

DET-1600 DETONATION SENSING MONITOR



6.4 FILE

6.4.1 LOAD FROM A FILE

The **LOAD** feature allows the user to load a previously saved detonation configuration file (.dcf) to the terminal program. To load a file, disconnect from the **DET-1600** using the **Disconnect** command; select **FILE**, then **LOAD**. In the list that opens, select the drive, folder, and desired file. The data will be loaded into the terminal program but not into the unit. Connect to the **DET-1600** to upload the configuration parameters to the **DET-1600 Monitor**.

6.4.2 SAVE TO A FILE

The **SAVE** feature allows the user to save the setup to a file for later use in the same or another **DET-1600**. Once the setup is complete, use the **SAVE** button to save the parameters to a file on the PC. The file extension preferred for the file is .dcf. So that the file format is similar use: **# of cylinders_cycles_engine type and numeric number**.

An example would be: **12_4_Wauk01.dcf**

6.5 COM PORT

Use the **COM Port Command Menu** to configure the PC to “talk” to the **Monitor: Com port “x”** (x is the com port used on the PC), **Baud Rate** (set to the same as the **DET-1600**, **1000ms Timeout**, **Parity none**, and **1 Stop Bit**.

6.6 SLAVE ID

Set the **Slave ID** to match the **DET-1600 Node Number**. **SEE SECTION 16.9**.

6.7 CONNECT/DISCONNECT

Use this **Command Menu** to begin communications with the **DET-1600**, **Connect**, or to end communications, **Disconnect**.

6.8 RESET COM STATS

Use the **Reset COM Stats Command Menu** to zero out any past communication errors to the **DET-1600**.

6.9 ROI – (REMOTE OPERATOR INTERFACE)

ROI mimics the **DET-1600** LCD and keypad on the PC screen. The **ROI** unit shows the LCD screens on the PC the same as the **DET-1600** monitors’ LCD screens. The **ROI** virtual keypad keys can be used to navigate the menus the same as pressing the keypad keys on the **DET-1600**. This is especially useful during the live calibration on the engine. Both the terminal program and the **ROI** monitor can be seen together on the PC’s screen. Click on the **ROI Command Menu** to bring up the **ROI**.

7.0 CONFIGURATION PARAMETERS – GENERAL SETUP



7.1 # OF CYLINDERS

Enter the number of engine cylinders from **1** to **16**. The # of cylinders and cycles is used in conjunction with the ignition shutdown lead to calculate engine rpm and windows.

7.2 CYCLES

Enter **2** for a two-, or **4** for a four-stroke engine.

7.3 AUTOSCAN

The time entered here in seconds will be used by the **DET-1600** as the display time for each cylinder channel when automatically displaying the home screen channels. If zero is entered, the display will remain on the displayed channel until it is advanced using the keypad. The range is **0** to **30** seconds.

7.4 LAG FILTER

The lag filter is used to stabilize the display reading of the detonation and misfire numbers displayed on the LCD from a changing sensor input signal. The output reaction time is directly tied to the lag filter. Misfire and detonation have separate lag filters allowing for customization of each. The rate of change is less for large values. The filter value range is **from 1 to 255**, **1** being no filter value and **255** being maximum filter value. A typical filter value might be **240**.

7.5 DISPLAY VALUES BY TEN

When **Display values by ten** is enabled the detonation and misfire reference numbers on the lcd will display in tens (the far right digit will always be **0**).

DET-1600 DETONATION SENSING MONITOR

7.6 MAP SENSORS

The **MAP SENSOR** table assigns a unique cylinder identification label to each channel. The **DET-1600** must be wired to match the firing order of the engine. The **DET-1600** reads each sensor in the **Firing Event** order from **1** to max number of cylinders. The **fire event** is the order of the ignition shutdown lead pulses.

- The **Fire Event** is from **1** to **x** in numerical order, **x** being max. number of engine cylinders.
- The **Cyl lbl** is a unique programmable engine cylinder identifier. The cylinder label is displayed on the LCD to describe each cylinder channel in the home screens. The cylinder label can be up to any two alphanumeric characters to describe the cylinder number. **Examples are 1, 5, etc. or 1R, 6L etc. or A, B, etc.**
- The **Sensor #** is the sensor that will be used by the **DET-1600** to listen for detonation and misfire for the particular cylinder or fire event. The sensor number should be the same as the firing event number except in special applications.

Examples of applications:

Example 1 **One sensor per cylinder on 6 cylinder inline engine**

Firing order: **1-5-3-6-2-4**

Sensor configuration: **Sensor #1 for cylinder #1**
Sensor #5 for cylinder #5
Sensor #3 for cylinder #3
Sensor #6 for cylinder #6
Sensor #2 for cylinder #2
Sensor #4 for cylinder #4

Fire Event (also terminal # on back of DET-1600)	1	2	3	4	5	6
Cyl lbl (identifier shown on LCD)	1	5	3	6	2	4
Sensor #	1	5	3	6	2	4

Example 2 **One sensor per cylinder on a 12 cylinder “V” engine.**

Firing order: **1R-6L-5R-2L-3R-4L-6R-1L-2R-5L-4R-3L**

Sensor configuration: **Sensor #1 for cylinder 1R**
Sensor #12 for cylinder 6L
Sensor #5 for cylinder 5R
... **...**
Sensor #9 for cylinder 3L

Fire Event (also terminal # on back of DET-1600)	1	2	3	4	5	6	7	8	9	10	11	12
Cyl lbl (identifier shown on LCD)	1R	6L	5R	2L	3R	4L	6R	1L	2R	5L	4R	3L
Sensor #	1	2	3	4	5	6	7	8	9	10	11	12

7.7 SECURITY SEE SECTION 16.10 FOR EXPLANATION.

7.8 TIMING DATA INPUT

The **Timing Data Input** selection is used to specify the source of ignition timing information. In order to calculate and display the correct engine retard value on the LCD, the **DET-1600** must know the timing value of where the engine runs at normal load, or the **Normal Run Timing Value**. If set to **User Value**, the **DET-1600** uses the normal run timing value entered by the user in the **Normal Run Timing Value** entry box. If the **DET-1600** is configured to receive its timing information from the ignition system via the **RS485 Master Modbus** port, **From Ignition System** should be selected.

7.9 USER ENTERED VALUE

Select this option when configuring the **DET-1600** to retard ignition timing using the ignition systems **4-20mA** input.

7.9.1 NORMAL RUN TIMING VALUE

The **Normal Run Timing Value** is the timing value in °btdc (degrees before-top-dead-center) that the engine runs at with normal loads. The **DET-1600** will use this number as the maximum advanced timing value and can only retard the engine timing from this value.

IMPORTANT: In order for the **DET-1600** to calculate and display the correct retard timing value the **Normal Run Timing Value** must match the engine timing. Ignition timing must be verified on the engine with a timing light.

7.10 FROM IGNITION SYSTEM

Select this option to configure the **DET-1600** to receive and send ignition timing via modbus from the ignition system.

7.10.1 IGNITION TIMING MODBUS REGISTER

The **Ignition Timing Modbus Register** is the Modbus register location number in the ignition system that will be used by the **DET-1600** to read the ignition timing.

IGNITION SYSTEM	REGISTER#
CD200	30006
CPU-95 ENHANCED DISPLAY MODULE	30130

7.10.2 IGNITION NODE ID

Enter the ignition system node **ID**. Must match ignition system's node **ID**. Must be different from **DET-1600**'s node ID number.

7.10.3 IGNITION BAUD RATE

Select the baud rate that matches the ignition system baud rate.

7.10.4 TIMING READ FROM IGNITION

The actual timing read from the ignition system at the ignition register number entered in the **Ignition Timing Modbus Register**.

DET-1600 DETONATION SENSING MONITOR

8.0 CONFIGURATION PARAMETERS – SETPOINTS/OUTPUTS

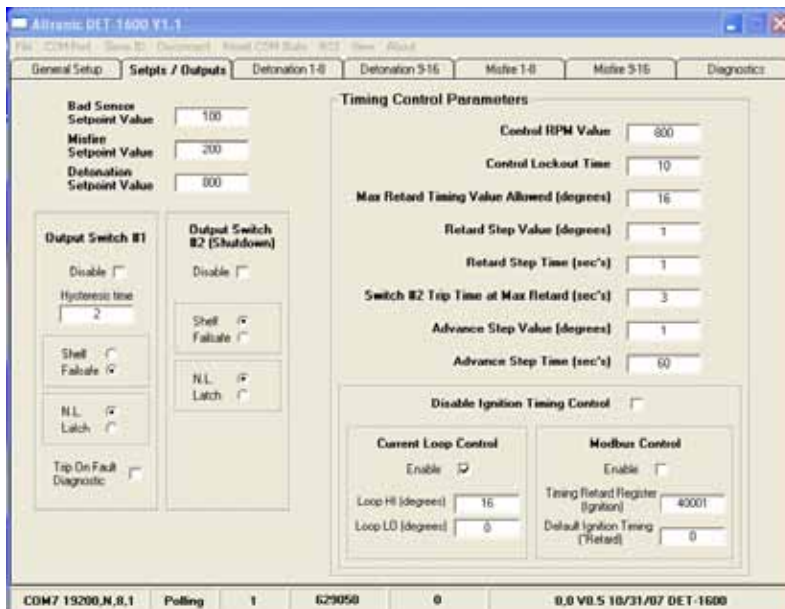

8.1 DETONATION SETPOINT VALUE

The **Detonation Setpoint Value** is a user-configurable high setpoint. It is used to trigger the **DET-1600** to take action if the detonation level value measured from any sensor goes above the setpoint caused by a sustained detonation in the corresponding cylinder. Output switch **#1**, Ignition retard, and output switch **#2** (when these are configured to do so) will take action when detonation is sensed. If detonation is detected, a **D** will be displayed on the home screen in the lower right corner of the affected cylinder channel. The value entered should be noticeably above the normal engine reference level. A typical value entered for a detonation number might be **800**; assuming the **DET-1600** detonation parameters are adjusted to display a nominal reference level of **500**. The range is from **0 to 999**. The value should be fine tuned when on a live engine.

8.2 MISFIRE SETPOINT VALUE

The **Misfire Setpoint Value** is a user-configurable low setpoint value. It is used to trigger the **DET-1600** to take action if the misfire level value measured from any sensor goes below the setpoint caused by a sustained misfire in the corresponding cylinder. Output switch **#1** (when enabled) will activate when misfire is sensed. If misfire is detected, an **M** will be displayed on the home screen in the lower right corner of the affected cylinder channel. The value entered should be noticeably below the normal engine reference level and above the **Bad Sensor Setpoint Level**. A typical value entered for a misfire number might be **200**; assuming the **DET-1600** detonation parameters are adjusted to display a nominal reference level of **500**. The range is from **0 to 999**. The value entered should be fine-tuned when on a live engine.

8.3 BAD SENSOR SETPOINT VALUE

The **Bad Sensor Setpoint Value** is a user-configurable low setpoint value. It is used to trigger the **DET-1600** to take action if the knock sensor or its wiring for any monitored cylinder goes open or shorted. A bad sensor will cause the input to go low. When the reference number for any input goes below the bad sensor setpoint value set, the monitor will register a bad sensor. A bad sensor indicator can be triggered by either the misfire reference level or the detonation reference level measured; however misfire has priority. If a bad sensor is detected, an **S** will be displayed on the home screen in the lower right corner of the affected cylinder channel. The **Bad Sensor Setpoint Value** is a low setpoint. Output switch #1 can be configured to take action by selecting **Trip On Fault Diagnostic**. The value entered should be below the misfire setpoint value but above zero. Please note that the input does not go to zero with an open sensor during operation, the input is affected by the electrical noise impressed on the input. The range of the bad sensor setpoint level is **0 to 999**, the default value for a bad sensor is **50**. The value entered should be fine-tuned when on a live engine.

8.4 OUTPUT SWITCH #1

Output switch #1 is designed to be used as a load control output. The switch is activated when either a **Misfire Setpoint Value** or a **Detonation Setpoint Value** is violated for any of the monitored cylinders. Please note that switch #1 (as well as timing control) is locked out by the **Control RPM Value** and the **Control Lockout Time** timing control parameters during start-up. In simple systems (without load control and analog timing control) switch #1 can be used as a one-step timing adjust contact. Connect the switch contact to the ignition system one-step timing control input.

8.4.1 DISABLE

If **Disable** is selected, output switch #1 will not activate.

8.4.2 NONLATCH OR LATCH

Switch #1 can be configured for latching or nonlatching. When set to **Latch** the switch will stay tripped continuously until it is either reset manually (using the **RESET** key on the keypad), a reset is sent via **Modbus** or by cycling the power. When set to **Nonlatch** the switch will stay tripped if any channel's reference number is below the misfire setpoint or above the detonation setpoint. It will automatically reset when the detonation or misfire values have returned to within the limits plus the hysteresis time set.

8.4.3 HYSTERESIS TIME

A **Hysteresis Time** can be used when the output switch is configured as nonlatching to prevent it from oscillating or turning on and off around the setpoint. When, after having been outside the setpoint value limits, the detonation or misfire reference level returns to within the setpoint value limits, the hysteresis timer starts and the switch stays tripped for the configured hysteresis time. If during the hysteresis time the setpoint is violated again, the hysteresis timer starts over. The hysteresis timer value is for switch #1 and is common for both the detonation and misfire setpoints. The hysteresis value can be set from **0 to 999** seconds.

DET-1600 DETONATION SENSING MONITOR

8.4.4 SHELF OR FAILSAFE STATE

Switch #1 is a closed switch when in the shelf state (with the absence of power). The switch can be configured for either fail-safe or shelf state. When set to **Shelf** state, the output switch will be closed when no setpoint values are violated. When set to **Failsafe**, the output switch will be open when no setpoint values are violated. If set to **Failsafe** and the power is lost to the **Monitor**, the output switch will change states (it will close).

8.4.5 TRIP ON FAULT DIAGNOSTIC

The **DET-1600** monitors several diagnostic conditions and can alarm the user when these conditions occur. Along with the **Fault Diagnostic** menu on the **DET-1600** which shows these conditions, output switch #1 can be selected to open or close (depending on if it is set for **SHELF** or **FAILSAFE**.)

Bad Sensor, **Misfire**, and **Detonation**, along with the diagnostics listed in **SECTION 10.0**, when faulted or diagnosed, will display **VIEWALARMS** alternating with the current condition on the LCD. Press the view alarms key to view and acknowledge the cause of the condition. The **ENTER/ACK** key when pressed will acknowledge the condition.

8.5 OUTPUT SWITCH #2

Output Switch #2 is designed to be used as an engine shutdown output. The switch is activated after switch #1 has tripped, the **Max Retard Timing Value** is reached, and the **Time Before Tripping Switch #2** has elapsed. The switch can be connected to an **Altronic Annunciator System**, an ignition low voltage shutdown input, or to pilot-duty relays.

8.5.1 DISABLE

If **Disable** is selected, output switch #2 will not activate.

8.5.2 SHELF or FAILSAFE STATE

Switch #2 is an open switch when in the shelf state (with the absence of power). The switch can be configured for either **Failsafe** or **Shelf** state. When set to **Shelf** state, the output switch will be open for normal run conditions. When set to **Failsafe**, the output switch will be closed for normal run conditions. If set to **Failsafe** and the power is lost to the **Monitor**, the output switch will change states (it will open).

8.5.3 NONLATCH or LATCH

Switch #2 can be configured for latching or nonlatching. When set to **Latch** the switch will stay tripped continuously until it is either reset manually (using the **RESET** key on the keypad), a reset is sent via **Modbus** or by cycling the power. When set to **Nonlatch**, the switch will stay tripped when the **Monitor** is at the **Max Retard Timing Value Allowed** but will automatically reset when the **DET-1600** returns the engine timing to a no retard condition.

8.6 TIMING CONTROL PARAMETERS

These parameters control when and how the **DET-1600** controls engine timing to protect the engine from detonation.

8.6.1 CONTROL RPM VALUE

When the engine is started and the rpm is below the **Control RPM Value**, the **DET-1600** will not activate the outputs. It will act as a monitor only. This will allow the engine to start and become stable without the control outputs taking effect. Once the **Control RPM Value** has been reached and the **Control Lockout Time** has elapsed, the outputs will be enabled and can take action. The range is **200 to 3000 rpm**.

8.6.2 CONTROL LOCKOUT TIME

The **Control Lockout Time** starts when the **DET-1600** has started and reached the **Control RPM Value**. The output switches, current loop, and **Modbus** control are disabled during this start-up time. This allows the engine to stabilize without any of the outputs (switches or control) interfering with engine start-up and loading. If at any time the engine rpm goes below the **Control RPM Value** the timer resets and starts again. During this time the LCD shows **Not Armed**. If a misfire, detonation or bad sensor occurs, the associated designator (**M**, **D**, or **S**) will be displayed on the home screen on the affected cylinder channel. Enter a time from **1 to 999** seconds. After the timer has expired the outputs will be enabled.

8.6.3 MAX RETARD TIMING VALUE ALLOWED

The **Max Retard Timing Value Allowed** is the maximum amount of retard that the **DET-1600** can impose on the engine via the ignition system in order to control detonation. For example, if the ignition system's normal run timing value is **24°btdc**, the **Normal Run Timing Value** would be set to **24°btdc**, and if the **Max Retard Timing Value Allowed** is set to **10** degrees, the maximum retard imposed by the **DET-1600** would be a maximum of **24 - 10 = 14°btdc**.

When the **Max Retard Timing Value Allowed** is reached and the **Retard Step Time** elapses, there is nothing more that the **DET-1600** can do to control detonation, switch #2 will trip. Switch #2 should be wired to shut down the engine to prevent damage.

8.6.4 RETARD STEP VALUE

The **Retard Step Value** is the amount of retard in degrees that the control output will change for each step when taking timing retard action to control detonation. The range is **0 to 10** degrees.

For example, if the **Max Retard Value** is **12** degrees and the **Retard Step Value** is **2** degrees, the **DET-1600** will retard the ignition timing **2°**, wait the **Time Between Retard Steps**, retard another **2°** etc.

8.6.5 RETARD STEP TIME

The **Retard Step Time** is the amount of time in seconds that the control output will wait between retard steps when taking retard action to control detonation. The range is **0 to 999** seconds.

DET-1600 DETONATION SENSING MONITOR

8.6.6 SWITCH #2 TRIP TIME AT MAX RETARD

When the **Max Retard Value Allowed** is reached, the **DET-1600** will wait the configured **Retard Step Time**. If this time has expired and detonation is still detected, it will wait the **Switch #2 Trip Time** before tripping output switch #2 and shutting down the engine (if switch #2 is set up to shut the engine down). The range is **0 to 999** seconds.

8.6.7 ADVANCE STEP VALUE

The **Advance Step Value** is the amount of advance degrees that the control output will change for each step when returning to the normal run ignition timing value when no detonation is detected. The range is **0 to 10** degrees.

8.6.8 ADVANCE STEP TIME

The **Advance Step Time** is the amount of time in seconds that the control output will wait between **Advance** steps when returning to the normal run ignition timing value when no detonation is detected. The range is **0 to 999** seconds.

8.6.9 DISABLE IGNITION TIMING CONTROL

Use this selection to disable both the current loop control and the Modbus control outputs. This has no effect on the output switches. Please note that the logic is not disabled, only the outputs are disabled. Switch **2** will still trip if and when it is configured to do so. This feature is accessible from either the **Terminal Program** or the **DET-1600** setup menu.

8.6.10 CURRENT LOOP CONTROL

The **Current Loop Control** is an output from the **DET-1600** designed to connect to the ignition system current loop input to retard the ignition timing when the **Monitor** detects either misfire or detonation. Enable the **Current Loop Control** by selecting the check box on the terminal program or from the menu in the **DET-1600**. Use the **Loop LO** and **Loop HI** configuration parameters to set the range in degrees retard, essentially the two endpoints. The output can be configured for forward or reverse acting. For forward acting, or increasing retard with increasing current, set the **4mA** point for zero retard and the **20mA** point to a max retard value in engine degrees. For reverse acting, or decreasing retard with decreasing current, set the **4mA** point for max retard and the **20mA** point to zero retard. As an example; to increase ignition retard with increasing current from **0** degrees retard to **24** degrees retard, enter the **Loop LO** point at **0** degrees and the **Loop HI** point at **24** degrees retard.

When configuring the **Current Loop Control**, confirm and match the ignition system current loop input parameters so that each system works together as desired. The **Current Loop Control** works in conjunction with the **Max Retard Value Allowed**, **Retard and Advance Step Values**, and the **Time Between Advance and Retard Step** parameters.

NOTE: Typically, the use of either the **Current Loop Control** or the **Modbus Control** outputs from the **DET-1600** will be used to control the ignition timing, **not both**.

8.6.11 MODBUS CONTROL

The **Modbus Control** is an output from the **DET-1600** designed to connect to the ignition system's **RS485** communications port to retard the ignition timing when the Monitor detects detonation. Enable the **Modbus Control** by selecting the check box on the terminal program or from the menu in the **DET-1600**. Select **From Ignition System** located on the **General Setup** tab and set the parameters associated with it for modbus control. **SEE SECTION 7.9**. The **Modbus Control** works in conjunction with the **Max Retard Value Allowed**, **Retard and Advance Step Values**, and the **Time Between Advance and Retard Step** parameters.

8.6.12 TIMING RETARD REGISTER (IGNITION)

This is the register number in the ignition system that the **DET-1600** will use to retard the timing when detonation is sensed.

IGNITION SYSTEM	REGISTER#
CD200	40007
CPU-95 ENHANCED DISPLAY MODULE	40001

8.6.13 DEFAULT IGNITION TIMING (°RETARD)

The **Default Ignition Timing** is the timing value in °btdc (degrees before top-dead-center) at which the engine runs under normal loads. It is a user-entered value. On the **CPU-95 Enhanced Display Module** the **DET-1600** uses the **Manual Retard** value to retard ignition timing. When the **DET-1600** is talking to the **CPU-95 Enhanced Display Module** the **Manual Retard** value can only be changed by the **Default Ignition Timing** value in the **DET-1600**. When installing the **DET-1600**, and if **Modbus Control** is used to retard the ignition timing, set the **Manual Retard** value for the **CPU-95 Enhanced Display Module** in the **Default Ignition Timing** entry box.

On the **CD-200 Ignition System** the **DET-1600** uses the **Insertion Retard** value to retard ignition timing. When the **DET-1600** is talking to the **CD-200 Ignition System**, the **Insertion Retard** value can only be changed by the **Default Ignition Timing** value in the **DET-1600**. When installing the **DET-1600**, and if **Modbus Control** is used to retard the ignition timing, set the **Insertion Retard** value for the **CD-200 Ignition System** in the **Default Ignition Timing** entry box.

IMPORTANT: In order for the **DET-1600** to calculate and display the correct retard timing value the **Default Ignition Timing** value must match the engine timing. Ignition timing must be verified on the engine with a timing light.

DET-1600 DETONATION SENSING MONITOR

9.0 DETONATION/MISFIRE

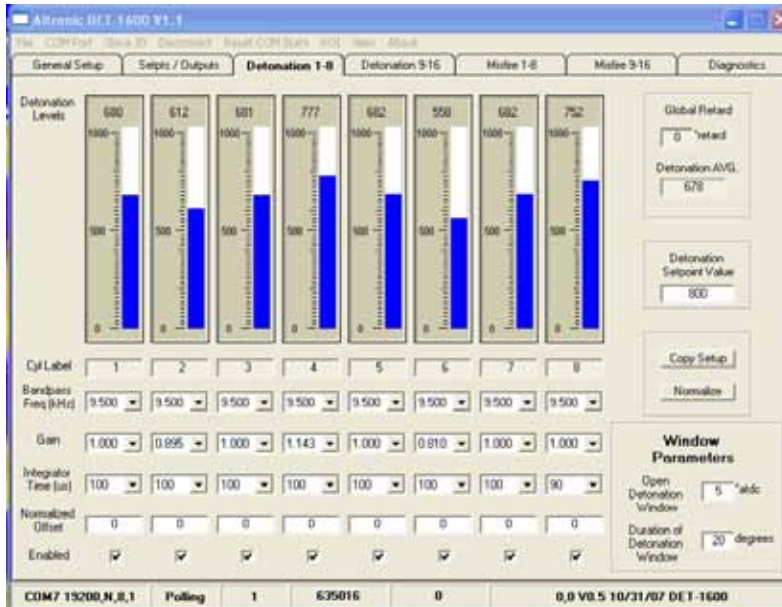

9.1 DETONATION/MISFIRE LEVEL, LINEAR GAUGES

The linear gauges on the detonation and misfire tabs (on the terminal program) are used to show the detonation and misfire levels for each cylinder. Each gauge is arranged above the signal processing parameters for the corresponding cylinder so that the levels can easily be assessed when calibrating the **DET-1600** on a live engine. The range is from 0 to 999 and the **ON** level is shown as filled. The reference number for each cylinder is shown at the top of each gauge. The cylinder label for each gauge is shown below the gauge.

9.2 AVERAGE DETONATION/MISFIRE LEVEL

The average detonation and misfire level for all of the configured and enabled cylinders is calculated and displayed in the **Detonation AVG.** text box for detonation and the **Misfire AVG.** for misfire. The average detonation and misfire levels can be used when calibrating the **DET-1600** to achieve a nominal reference level.

9.3 GLOBAL RETARD

The **Global Retard** is the amount of retard imposed on the ignition system by the **DET-1600** when detonation is detected. The amount is determined from the user entered **Retard Step Value**. This is a read-only value. The value is also shown on the **DET-1600's** home screen. An example of the calculated value would be if the user entered **24° btdc** for the **Normal Run Timing Value** and the **DET-1600** is imposing **5°** of retard, a value of **5°** retard would be displayed.

9.4 SIGNAL PROCESSING PARAMETERS

The signal processing parameters are band-pass frequency, gain, and integrator time constant. The **DET-1600** allows each cylinder to be individually tuned to allow for the variance of the signal it receives from the configured knock sensor. Gain, band-pass frequency, and inte-

grator time constant can be configured separately for each cylinder for detonation and misfire. When configuring each cylinder input for misfire detection, these parameters are used to calibrate the cylinder's sensor for a low signal, or the absence of a normal combustion process. When configuring each cylinder input for detonation detection, these parameters are used to calibrate the cylinder's sensor for a high signal, or extra noise signal (detonation) at a determined center or band-pass frequency. Use the selection boxes in the terminal program to configure the signal processing parameters for each cylinder for both detonation and misfire. Generally each parameter should be configured in the order of band-pass, gain, and then integrator. It is imperative to equalize each cylinder's reference number because of the common detonation, misfire and bad sensor setpoints.

9.4.1 BAND-PASS FREQUENCY

The band-pass filter is used to pass the knock induced vibrations (frequencies) within a certain range and reject (attenuate) the unwanted normal occurring mechanical engine vibration frequencies that occur in normal engine operation (frequencies that are outside that range). The desired frequencies may be different depending on if we are detecting misfire or detonation, the engine type, engine speed, the characteristics of the particular engine, and the sensor type and location. A starting point for the band-pass frequency can be calculated by using the formula: **frequency in Hz = (25,140/bore (inches)) x 3**. For a **9.5"** bore, the calculation equals **7939Hz**. The closest frequency that can be chosen from the menu is **8.020kHz**. The final band-pass frequency value should be fine-tuned during a live calibration on the engine. The center frequency of the band-pass range can be selected from **1.22kHz** to **19.98kHz** in **64** steps. Note that on smaller bore engines a multiplication factor of **x2** may be a better starting point.

9.4.2 GAIN

The gain adjustment is used to amplify the signal from the knock sensor. It is used to compensate for different levels of signals from the sensors due to different loads, rpm's and distances from the source. The gain is used to equalize the output from each sensor to achieve a similar reference number for each cylinder. A starting gain value might be **1**. The final gain value should be fine tuned during a live calibration on the engine. **64** different gain settings can be selected from **.111** (a small gain value) to **2** (a large gain value).

9.4.3 INTEGRATOR TIME

The integrator time value is the amount of input signal of the filtered sensor signal realized by the reference number. It is the resolution of the signal seen for a given time period. A shorter integrator time value will result in a larger output value. Longer integration times will result in a smaller output value. A starting integrator value might be **200**. The final integrator value should be fine tuned during a live calibration on the engine. It should be chosen to equalize the reference numbers for each cylinder. The integrator time constant can be configured from **40us** to **600us** in **32** steps.

DET-1600 DETONATION SENSING MONITOR

9.5 NORMALIZED OFFSET

The **Normalized Offset** value is an addition or subtraction from the reference number. It allows for further equalization of each individual cylinder's reference number to the others. It is typically set to zero unless the cylinder's reference numbers cannot be equalized with the signal processing parameters. It can also be used to adjust a cylinder's reference number when a bad sensor was replaced to equalize it to the others to avoid changing the signal processing parameters. The maximum offset value is **500**.

9.6 ENABLED

Enabled is used to enable/disable each cylinder individually from its ability to affect the output switches, ignition retard control and average detonation and misfire levels. When disabled, the LCD will show a dash (-) in the lower right corner of the LCD for that cylinder.

9.7 DETONATION/MISFIRE SETPOINT VALUE

REFER TO SECTIONS 8.1 AND 8.2.

These values are displayed on the detonation and misfire screens in the terminal program for convenience during live engine calibration. These values can be changed from this screen.

9.8 COPY SETUP

Copy Setup copies the signal processing parameters from cylinder **#1** and pastes them to the other configured cylinders. The copy command is separate for detonation and misfire. For ease of setup, this allows the user to place only cylinder **#1** in detonation and then calibrate the signal processing parameters for cylinder **#1**. Once the parameters have been calibrated for cylinder **#1**, they can be applied to the other cylinders. Each cylinder can be individually adjusted from the copied parameters if further adjustment is needed.

9.9 NORMALIZE

Normalize can be used to automatically equalize the configured channels to the average of all of the cylinders. Given that there is one common setpoint for all of the cylinders, the reference numbers during normal run (when no detonation or misfire is occurring) should be similar. The **Normalize** feature automatically adds or subtracts an offset value to each cylinder's reference number. The offset number is displayed for each cylinder in the **Normalized Offset** box. Click the **Normalize** button and a pop-up box with the calculated average of the configured and enabled cylinders will appear, either press **Enter** to accept or type in a preferred number and press **Enter**.

9.10 WINDOW PARAMETERS

The **Window Parameters** are **Open Detonation/Misfire Window** and **Duration of Detonation/Misfire Window**. These user configurable parameters allow the **DET-1600** to detect detonation and misfire only during the expected time frame. The window parameters will be used at the configured time after top-dead-center for each cylinder. **REFER TO SECTION 5.4** for further description on windowing.

NOTE: *The window opening for each cylinder must not overlap into the next odd cylinder for the odd cylinder numbers, or even cylinder for the even cylinder numbers. The closing of a cylinder's window must occur at least 1 degree before the opening of the next odd or even cylinder's window opening. This is determined by the number of cylinders and the firing angle for each engine.*

When an engine detonates it occurs after top-dead-center, typically between **5°atdc** and **30°atdc**, depending on the engine. The optimum window start and stop time depends on engine speed, engine timing, and load. The window **Open** and **Duration** parameters can independently be adjusted for misfire and detonation.

Use the following formula to calculate the maximum allowable window opening:

$$((360 * \text{Cycle}/2) / \#\text{cyls}) * 2$$

Ex: 16 cyl, 4 cycle $((360 * 2) / 16) * 2 = 90$ degrees max window opening.

The Normal Run Timing value + Open Window value + Duration of Window value must be less than the maximum allowable window size.

9.10.1 OPEN MISFIRE WINDOW

The **Open Misfire Window** parameter is the position in crankshaft degrees after-top-dead-center (atdc) that the **DET-1600** will start to detect misfire for each cylinder. The range is **0°atdc** to max window opening **-1**.

9.10.2 DURATION OF MISFIRE WINDOW

The **Duration of Misfire Window** is the window open time, or duration, in absolute crank angle degrees that the **DET-1600** will detect misfire for each cylinder. The range is **1** to max window opening.

9.10.3 OPEN DETONATION WINDOW

The **Open Detonation Window** parameter is the position in crankshaft degrees after-top-dead-center (atdc) that the **DET-1600** will start to detect detonation for each cylinder. The range is **1°atdc** to max window opening **-2**.

9.10.4 DURATION OF DETONATION WINDOW

The **Duration of Detonation Window** is the window open time, or duration, in absolute crank angle degrees that the **DET-1600** will detect detonation for each cylinder. The range is **1** to max window opening.

DET-1600 DETONATION SENSING MONITOR

10.0 DIAGNOSTICS

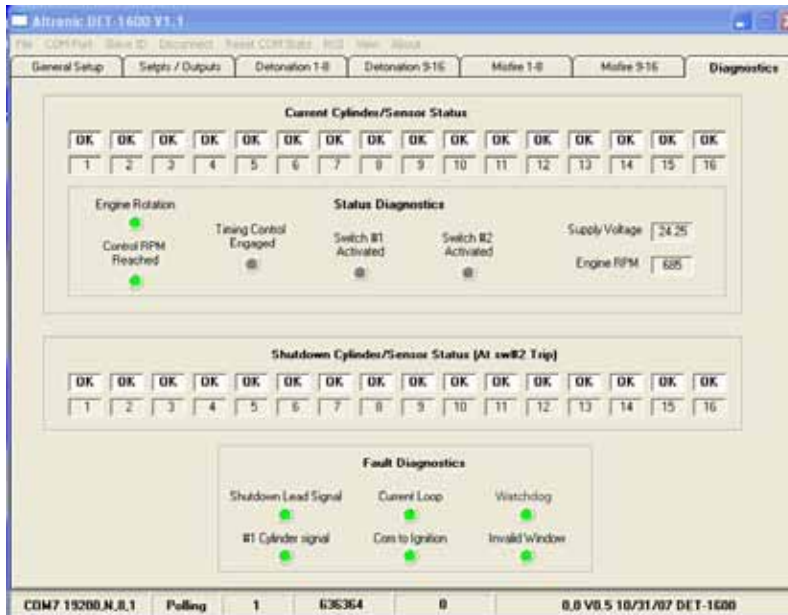

10.1 The diagnostics tab can be used to get an overall view of the status for both the current condition of the system as well as the faulted condition. The **Cylinder/Sensor Status**, **Status Diagnostics**, and **Fault Diagnostics** are the current condition of the **Monitor**, while the **Shutdown Cylinder/Sensor Status** is the history of the sensor status of the **Monitor**.

10.2 CYLINDER/SENSOR STATUS – The **Cylinder/Sensor Status** is used to show collectively the current live status of each input. The status will change with each condition change. Each configured input will show **OK, D, M, S, or -**.

- **OK** The reference number is between the misfire and detonation levels and is working properly
- **D** The reference number is above the detonation setpoint value
- **M** The reference number is below the misfire setpoint value
- **S** The reference number is below the bad sensor setpoint value
- **-** The input is disabled

10.3 STATUS DIAGNOSTICS

The **Status Diagnostics** are an indication of each parameter's current condition.

10.3.1 ENGINE ROTATION

The indicator will be on when the **DET-1600** is above the indication rpm. Minimum rpm is **200** rpm.

10.3.2 CONTROL RPM REACHED

The indicator will be on when the engine rpm is above the configured control rpm.

10.3.3 TIMING CONTROL ENGAGED

The indicator will be on when the ignition timing control is engaged.

10.3.4 SWITCH #1 ACTIVATED

The indicator will be on when **Switch #1** is activated.

10.3.5 SWITCH #2 ACTIVATED

The indicator will be on when **Switch #2** is activated.

10.3.6 SUPPLY VOLTAGE

The supply voltage seen by the **DET-1600** will be displayed in the text box.

10.3.7 ENGINE RPM

The engine rpm calculated by the **DET-1600** will be displayed in the text box.

10.4 SHUTDOWN CYLINDER/SENSOR STATUS

The **Shutdown Cylinder/Sensor Status** is used to show collectively the status of each input at shutdown. A snapshot of the condition of the cylinder sensors is taken when switch **#2** (the shutdown switch) trips. Each configured input will show **OK, D, M, S,** or **-** and will remain until reset is performed either by the keypad or Modbus communications. These conditions will remain with the interruption of power.

- **OK** The reference number is between the misfire and detonation levels and is working properly
- **D** The reference number is above the detonation setpoint value
- **M** The reference number is below the misfire setpoint value
- **S** The reference number is below the bad sensor setpoint value
- **-** The input is disabled

10.5 FAULT DIAGNOSTICS

The **Fault Diagnostics** are an indication of each parameter's condition. These can be used if the **DET-1600** is not operating properly.

10.5.1 SHUTDOWN LEAD SIGNAL

The indicator will be on when the **DET-1600** senses voltage on the shutdown lead. Minimum voltage is **75** volts peak.

10.5.2 #1 CYLINDER SIGNAL

The indicator will be on when the **DET-1600** senses voltage from the **#1** coil primary. Minimum voltage is **75** volts peak.

10.5.3 CURRENT LOOP FAULT

The indicator will be on if the current loop is activated and the loop wiring becomes disconnected, open or shorted.

10.5.4 COMMUNICATION TO IGNITION

The indicator will be on when the **DET-1600** is configured to talk to an ignition system and communications is established on the **RS485 Modbus Master** port.

10.5.5 WATCHDOG

The **DET-1600** Detonation Sensing Monitor contains an internal watchdog monitor. If the Monitor gets interrupted by either an undervoltage condition or unusual EMI spike, etc., the internal watchdog will automatically set the Monitor back on track without interruption. No action is required by the user.



WARNING:

ADJUSTMENT OF THE ENGINE OPERATING PARAMETERS, INCLUDING ENGINE LOAD, SHOULD BE UNDERTAKEN ONLY BY QUALIFIED PERSONNEL WHO ARE FAMILIAR WITH THE ENGINE BEING SET-UP. HEAVY OR UNACCEPTABLE LEVELS OF DETONATION, AS DETERMINED BY SAID PERSONNEL, MUST BE AVOIDED AT ALL TIMES AND SHOULD SERVE AS A SIGNAL TO STOP THE ENGINE IMMEDIATELY TO PREVENT POSSIBLE ENGINE DAMAGE AND PERSONAL INJURY. AT NO TIME SHOULD THE ENGINE BE OVERLOADED.

11.0 LIVE CALIBRATION AT ENGINE SITE

Detonation or **Knock** is a condition that limits how efficiently an engine can operate. Severe knock is harmful to the engine and must be avoided. Controlling knock intensity is further complicated by engine cycle to cycle variations. Because of the variations of the detonation signal for each engine rotation the **DET-1600** must be set up for an average value from a large number of samples.

The terminal program is used to calibrate or “fine tune” the **DET-1600** on a live engine. Many of the parameters can be inserted using the terminal program on a bench but the monitor must be calibrated with the engine loaded.

11.1 EQUIPMENT NEEDED

Laptop computer with **DET-1600 Terminal Program** up and running. **RS485 Adapter** wired from the PC to the **DET-1600** (SEE FIG. 12). An oscilloscope would be helpful but is not required.

11.2 GETTING STARTED

At this point, the **DET-1600** system should be mounted and wired. Apply power to the system. The configuration parameters should have been entered either from a file that was saved from a previously configured similar application or from the default parameters suggested in this manual. Select **Connect** from the **Command** bar. Select from either the current configuration in the **DET-1600** or the configuration in the terminal program. Assure that the pre-configured parameters are accurate. Start and load the engine.

11.3 WINDOW SAMPLING PARAMETERS

Adjust the **Window Parameters** for both misfire and detonation. REFER TO SECTION 9.10. Ideal peak pressure in the cylinder occurs around **16°atdc**, so the window should be open before, and last longer than, **16°atdc**. A suggested starting point is **5 to 10°atdc** with a duration of **20** degrees.

Windows can also be calibrated with an oscilloscope. Connect channel **1** of the scope to trigger from the **#1** coil firing, and channel **2** of the scope to the knock sensor for cyl **#1**. Both of these signals are available on the back of the **DET-1600**.

For misfire setup, adjust the scope to display the normal cylinder firing signal coming from the sensor being observed on channel 2 of the scope. Use the signal observed and the scope settings to calculate the timing degrees. Adjust the window accordingly.

NOTE: A spreadsheet to aid in calculating crank angle timing is included on the CD enclosed with the DET-1600.

For detonation setup, create an incipient detonation condition. Adjust the scope to display the detonation peak signal coming from the sensor being observed on channel 2 of the scope. Use the signal and the scope settings to calculate the timing degrees. Detonation will typically occur between **5°atdc** and **30°atdc**. Adjust the window accordingly.



CAUTION:

ASSURE THAT THE WINDOWS CAPTURE THE SENSOR SIGNAL FOR ALL CONDITIONS. IF THE DETONATION OR MISFIRE SIGNAL IS NOT CAPTURED IN THE WINDOW OR IT GOES OUTSIDE OF THE WINDOW, ERRATIC OPERATION OF THE DET-1600 SYSTEM WILL OCCUR.

NOTE: The engine shutdown switch should be located and enabled prior to device setup.

11.4 SIGNAL PROCESSING PARAMETERS

Once the window parameters have been set, adjust the signal processing parameters (band-pass frequency, gain, and integrator time). Each of these parameters can be adjusted individually for each cylinder for both misfire and detonation. The best way to calibrate the **DET-1600** detonation signal processing parameters is if an actual signal for incipient detonation can be safely produced. If it is not possible to run the engine with incipient detonation, then typical values for a given engine model may have to be used as a calibration starting point. Adjust the band-pass first, then gain, then the integrator.



CAUTION:

REDUCE ENGINE LOAD WHEN CREATING A MISFIRE CONDITION. AN OVERLOAD CONDITION CAN OCCUR QUICKLY WHEN AN ENGINE IS NOT FIRING ON ALL CYLINDERS.

MISFIRE

Create a misfire condition on one of the cylinders. **DO NOT** open or short any cylinder's primary to cause a misfire. If cylinder #1's coil primary is shorted, a **Fault** diagnostic will occur, and the **DET-1600** will go to **NO RPM**. With the engine area confirmed to be non-hazardous by the use of a combustible gas detector, the misfire can be created by opening or grounding the coil secondary lead (spark plug lead) for that cylinder. If a misfire condition cannot be created safely, then a starting value for misfire of **250** based upon a normal signal level adjusted to **500** is a good starting point. Adjust the signal processing parameters for the cylinder that is misfiring. Set cylinder #1's parameters to the calibrated values. Use the **Copy Setup** button in the terminal program to copy these settings to the other cylinder channels. **SEE SECTION 9.8** for information regarding this feature.



WARNING:

IF HEAVY DETONATION IS HEARD AT ANY POINT DURING THESE SETUP OPERATIONS, STOP ENGINE IMMEDIATELY.

DET-1600 DETONATION SENSING MONITOR

11.4 SIGNAL PROCESSING PARAMETERS (continued)

DETONATION **SEE SECTION 5.1**

Create an incipient detonation condition on one of the cylinders (in this example cylinder #1 is used). If using a **CPU-95 Ignition System**, advance the global timing to a point of incipient knock and then use the individual cylinder timing adjustment feature on the **CPU-95** to force cylinder #1 into very light, incipient detonation (**SEE DEFINITION AT RIGHT**). Adjust the signal processing parameters for cylinder #1. Use the **Copy Setup** button in the terminal program to copy these settings to the other cylinder channels. **SEE SECTION 9.8** for information regarding this feature.

This should yield a good starting point for the signal processing parameters, particularly if each cylinder has its own sensor. Some further individual cylinder calibration may be required in order to attain the required similar reference number for all of the cylinders (the integrator may need to be tweaked). Please note that other schemes may need to be employed for one sensor for several cylinders.

NOTE: Incipient Detonation is a very light, barely audible knocking sound similar to the pinging sometimes heard in an automobile engine as the car starts up a steep hill.

11.4.1 BAND-PASS **SEE SECTION 9.4.1**

11.4.2 GAIN **SEE SECTION 9.4.2**

11.4.3 INTEGRATOR **SEE SECTION 9.4.3**

12.0 OPERATION

12.1 A **16-characterx2line** back-lit LCD display is used for a visual output of the system. A sealed membrane keypad is used to navigate the LCD screens. The **DET-1600** menu system allows the relevant operational parameters to be viewed and adjusted via the keypad when in use on the engine. A flowchart (**FIG. 2**) is included in this manual for reference. Configuration and calibration must be performed using the terminal program provided.

13.0 KEYPAD DESCRIPTION

13.1 The **DET-1600 Detonation Sensing Monitor** contains an eight-key front keypad which is used to view the reference data for each cylinder, view and change the setpoint values, view the diagnostic data, and to access the menu. The eight front panel keys are **VIEW ALARMS**, **RESET**, **SETUP**, **ENTER/ACK**, **SETPTS**, **ESC**, **▲**, and **▼** (up and down arrow keys).

13.2 VIEW ALARMS

The **VIEW ALARMS** key allows the user to view the alarms occurring when switch #2 trips and of any current fault diagnostic messages. The fault diagnostic messages will automatically clear when the fault diagnostic clears. Pressing **VIEW ALARMS** displays the alarms that occurred when switch #2 tripped. Each occurrence is displayed in the firing order. Additional key presses will show further occurrences. Each occurrence will appear once in the list. After displaying all of the captured occurrences, the display will ask **CLEAR STATUS**

LOG? Select **YES** and **ENTER** to clear the logs, **NO** to retain them. If no occurrences are logged, the display will show **CYL STATUS LOG/NONE**. Press **ESC** to return to the home screen.

13.3 RESET

The **RESET** key resets the loop to no retard, clears the output switch(es) and resets the control lockout timer. **SEE SECTION 14.3** for more information on reset.



CAUTION: PRESSING RESET WILL CAUSE THE TIMING TO ABRUPTLY RETURN TO THE FULL ADVANCED VALUE AND WILL CLEAR THE OUTPUT SWITCHES TO THEIR NOT TRIPPED POSITION.

13.4 SETUP

The **SETUP** key is used to scroll through the setup menu.

13.5 ENTER/ACK

The **ENTER/ACK** key is used to save new data or a new configuration in nonvolatile memory. The setup will remain even through power-down. The **ENTER/ACK** key is also used to acknowledge alarms.

13.6 SETPTS

The **SETPTS** (setpoints) key is used to view or change the setpoint values. **REFER TO SECTION 15.0** for more information. **NOTE:** The setpoints cannot be changed if the protection is set to **On**.

13.7 ESC

The **ESC** (escape) key can be used at any time during the setup, setpoint or view alarm modes to return to the home screen. When the **ESC** key is pressed in any configuration mode, any changed values are ignored (not stored in memory), the configuration returns to the previous values, and the display returns to the home screen. The **ESC** key is also used to toggle between the numerical and graphical home screens.

13.8 ▲ ▼

The up and down arrow keys are used to increment or decrement the displayed cylinder channel number and corresponding reference number. Each press of the up arrow key increments the channel one at a time while the down arrow key decrements it. These keys also scroll through the selections in the setup menu and are used to increase or decrease values for setpoints and setup values.

14.0 HOME SCREEN DESCRIPTION

When the **DET-1600 Detonation Monitor** is in the **home screen**, it displays the global system status on the first line along with switch 1 and 2 status. On the second line, the cylinder number (**XX**) and its corresponding reference numbers for detonation and misfire along with **D, M, S, or -** for **Detonation, Misfire, Bad Sensor, or Cylinder Channel Disabled Status** are displayed.

DET-1600 DETONATION SENSING MONITOR

14.0 HOME SCREEN DESCRIPTION (continued)

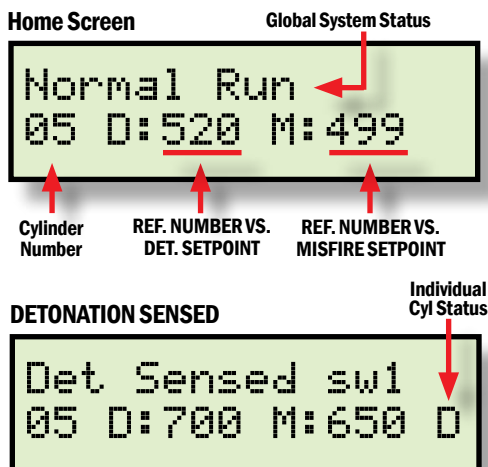

The cylinder number descriptions are one or two digits and can be configured from the terminal program for up to two ASCII characters. They will be shown in the fire event order as configured in the terminal program. Typical configurations are **01, 05, etc. or 1R, 6L**, etc.

The detonation (**D:**) and misfire (**M:**) numbers represent the detonation/vibration amplitude level from each cylinder. The numbers are unitless reference numbers with a range from **0** to **999**. Each configured cylinder has its own set of reference numbers. A larger number indicates a larger signal; a smaller number indicates a smaller signal.

D, M, S, or **-** for **Detonation, Misfire, Bad Sensor,** or **Disabled (D, M, S,** or **-)** will display in the lower right corner on the LCD of the affected cylinder number if the following conditions exist:

- **D = Detonation** – a cylinder is detonating
- **M = Misfire** – a cylinder is misfiring
- **S = Bad Sensor** – a cylinder has either a bad sensor, open or shorted wiring
- **- = Disabled** – a cylinder channel has been disabled

D, M, S, or **-** are mutually exclusive and have the following priority:

1. Disabled
2. Bad Sensor
3. Detonation
4. Misfire

Use ▲ or ▼ to scroll through the cylinder channels.

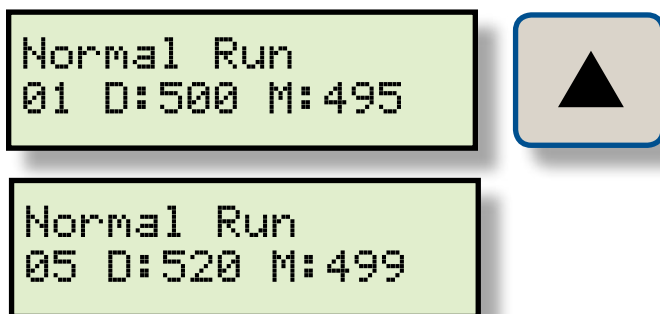

NOTE: If a sensor or its wiring becomes open, shorted, or disconnected from the DET-1600, the display will show "S" (bad sensor) on the corresponding LCD cylinder screen. If configured to trip on fault diagnostic, output switch #1 will activate.

14.1 SYSTEM STATUS

The first line of the display shows the global status of the **DET-1600** system. The system status descriptions are:

```
No RPM
01 D: 0 M: 0
```

No RPM is displayed on power-up of the **DET-1600**. **No RPM** indicates that power is applied to the **DET-1600** and the engine is not rotating (the **DET-1600** is not receiving the shutdown and #1 coil signals from the ignition system). The **D** and **M** numbers will be zero. The monitor is ready for engine start-up. **NOTE:** The minimum run rpm is **200**.

```
Not Armed
01 D:500 M:495
```

Not Armed is displayed upon engine startup indicating that the **DET-1600** is operating in monitor mode and will not activate the outputs. This allows the engine to start and stabilize without either of the output switches or control interfering with engine start-up and loading. The individual cylinder status indicators will display in this mode. The **Monitor** will remain in this mode until the engine rpm is above the **Control RPM Value** and the **Control Lockout Time** has expired.

```
Normal Run
01 D:500 M:495
```

Normal Run indicates the **DET-1600** is in normal operation mode. The **Control Lockout Time** has expired and engine rpm is above the **Control RPM**. The reference numbers from the sensors are being compared to the configured setpoints and the output switches and timing control will take effect upon a detonation or misfire condition.

```
Det Sensed sw1
05 D:725 M:650 D
```

Det Sensed is displayed if detonation is sensed on any input. A **D** will be shown in the lower right corner on each cylinder channel that is detonating. **sw1** will appear on the first line indicating that switch #1 (the load control switch) is activated.

DET-1600 DETONATION SENSING MONITOR

14.1 SYSTEM STATUS (continued)

```
Mis Sensed sw1  
03 D:325 M:235 M
```

Mis Sensed is displayed if misfire is occurring on any input. An **M** will be shown in the lower right corner on each cylinder channel that is misfiring. **sw1** will appear on the first line indicating that switch #1 (the load control switch) is activated.

```
Ign Ret 10° sw1  
05 D:815 M:650 D
```

Ign Ret xx° is displayed if detonation continues to occur. The **DET-1600** will send out a signal to retard the ignition timing (either by current loop or Modbus). **xx** represents the current amount of retard inflicted on the ignition system. Any one of the cylinder channel's that are violating the detonation setpoint value will cause the **DET-1600** to retard timing and display **Ign Ret**. The cylinder channel that is detonating will show a **D** in the lower right corner of the LCD.

```
Ign Ret 18° sw1 2  
05 D:825 M:675 D
```

sw1 = Switch #1 is activated – **sw1** will trip and display when switch #1 is activated by either detonation or misfire.

sw2 = Switch #2 is activated – **sw2** will trip and display if detonation is sensed, and continues, causing the ignition retard value to reach the **Max Retard Timing Value Allowed** and **Switch #2 Trip Time at Max Retard** to time out.

```
Bad Sensor  
03 D:50 M:55 S
```

ENTER
ACK

Bad Sensor is displayed if a sensor is determined to be open or shorted on a configured input. An **S** will be shown in the lower right corner on the respective cylinder channel. If **Output** switch #1 is configured to trip on fault diagnostic **sw1** will appear on the first line indicating that switch #1 is activated. Press the **ENTER/ACK** key to acknowledge the condition and clear the global **Bad Sensor** status.

```
View Alrms sw1 2
01 D: 0 M: 0
```

ENTER
ACK

View Alrms = View Alarms – When switch #2 trips, which is typically used to shut down the engine, the **View Alarms** message will blink alternately with the system status message. Press the **ENTER/ACK** key to acknowledge the condition. Press the **VIEWALARMS** key to view the Alarms message to see what caused the shutdown. **SEE SECTION 17.0** for further information on the **View Alarms** feature.

14.2 BARGRAPH

```
Det Sensed sw1
01 D:725 M:650 D
```

ESC

```
Det Sensed sw1
D■■■■■■■■■■■■■■■■
```

A bargraph screen showing each configured cylinder channel’s reference level in graphic form and whether a detonation **D**, misfire **M**, bad sensor **S**, or if the channel has been disabled -, is shown on the bottom row of the display. The top row remains the same. The bargraph screen is also considered a home screen. It can be used as a quick overview of each cylinder channel’s current condition. The graph is shown in the engine’s firing order. Each vertical bar is a cylinder channel. Only the configured channels are shown. To view the bargraph, press the **ESC** key from the numeric home screen. Press the **ESC** key again to return to the numeric home screen. There is no time-out for the bargraph screen; it will remain until **ESC** is pressed. The bargraph screen shown above is configured for 6 cylinders.

14.3 RESET

RESET

```
PERFORM RESET?
↑↓NO
```

Reset can be initiated in one of two ways: by pressing the **RESET** key or, by sending a reset command via the **RS-485** communications. Pressing **RESET** from the home screen resets the **Control Lockout Timer**, places the current loop and **Modbus** outputs to a no retard condition, and places the output switches in the non-tripped condition. When the reset key is pressed, the display will show **PERFORM RESET?**. The default is **NO**. Use the up or down arrow key to select **YES** and press **ENTER**.

DET-1600 DETONATION SENSING MONITOR

15.0 SETPOINTS

15.1 The setpoint menu allows adjustment of **MISFIRE**, **DETONATION**, **MAX RETARD VALUE**, **SWITCH 2 TRIP TIME AT MAX RETARD**, and **BAD SENSOR** setpoints. From the home screen, press the **SETPTS** key to access the setpoint menu. Press the **▲** or **▼** (up/down arrow keys) to adjust the setpoint value. Press **ENTER** to save the value. The LCD will show **SAVED** and return to the current screen. Press **ESC** to return to the home screen.

NOTE: When in the setpoints mode, the previous setpoint values are monitored, and the new value is monitored only after the ENTER key is pressed. If no key is pressed for 30 seconds, the display will return to the home screen and the previous value.

15.2 MISFIRE

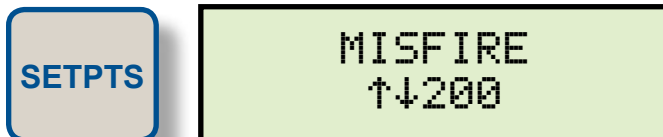

The misfire setpoint is a low setpoint. If the misfire reference number goes below the misfire setpoint, switch #1 will activate. The misfire setpoint can be set anywhere within the range of the scanner.

15.3 DETONATION



The detonation setpoint is a high setpoint. If the detonation reference number goes above the detonation setpoint, switch #1 will activate and the timing will be adjusted. The detonation setpoint can be set anywhere within the range of the scanner.

15.4 MAX RETARD VALUE

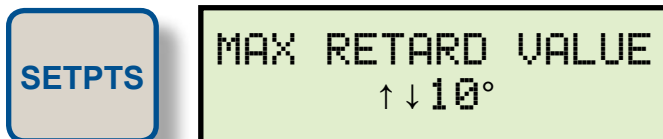

The **Maximum Retard Timing Value Allowed** is the maximum amount of retard that the **DET-1600** can inflict on the engine via the ignition system in order to control detonation. For example, if the ignition system's normal run timing value is **24°btdc** and the **Max Retard Timing Value Allowed** is set at **10** degrees, the **DET-1600** can retard the engine to a maximum of **14°btdc**. The max range is **0** to **90** degrees. The **Maximum Retard Timing Value Allowed** is also used as an indication to trip switch #2. When this point is reached, there is nothing more that the **DET-1600** can do to eliminate detonation. Switch #2 should be wired to shut down the engine to prevent damage. When the maximum retard timing value is reached, the **SWITCH 2 TRIP TIME AT MAX RETARD** timer begins. When the timer lapses, switch #2 will activate.

15.5 SW2 TRIP TIME @ MAX RETARD

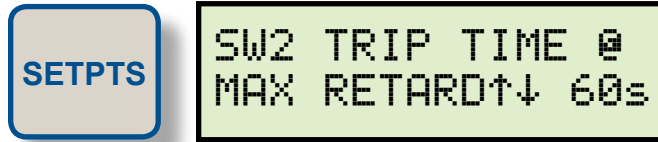

The **DET-1600** upon reaching the max retard value will wait the **Retard Step Time** plus the configured **Switch #2 Trip Time at Max Retard** before shutting down the engine (if switch #2 is set up to shut the engine down). The range is **0** to **999** seconds.

15.6 BAD SENSOR



The bad sensor setpoint is a low setpoint. If either the misfire reference number or the detonation reference number goes below the bad sensor setpoint, switch #1 will activate (Switch #1 must be configured in the terminal program; **Trip On Fault Diagnostic** check box must be checked). The bad sensor setpoint can be set anywhere within the range of the scanner.

DET-1600 DETONATION SENSING MONITOR

16.0 SCREEN MENUS

16.1 GENERAL INFORMATION – Configuration of the **DET-1600** must be performed using the terminal program. The screen menus on the **DET-1600** are used during operation of the system to view or modify the significant operating parameters.



Press the **SETUP** key to enter the menu from the home screen (**FIGURE 2** for a flowchart that shows step-by-step progression through the monitor's menu). Press the **SETUP** key to progress through the menu. Where arrows \updownarrow are shown, use the \blacktriangle or \blacktriangledown arrow keys on the keypad to increase or decrease values or to scroll through the selections. After making a change, press the **ENTER** key to save the configuration to memory; the display will read **SAVED**. It is at this time that the new data is saved. The **ESC** (escape) key can be used at any time to abort the menu and return to the home screen. During configuration, the gauge allows **30** seconds between keystrokes to change or save a new configuration. If the time lapses without a keystroke, the monitor will automatically return to the home screen without making any changes.

16.2 AUTOSCAN

AUTOSCAN 0-30s configures the display to scroll automatically between the configured cylinder channels. Autoscan can be set from **1** to **30** seconds or **OFF (0)**. With **AUTOSCAN** turned on, when in the numeric home screen, the gauge will display each channel for the selected time period before automatically switching to the next channel. The \blacktriangle arrow key can be used to quickly advance to the next channel. With **AUTOSCAN** turned **OFF**, the scanner continually displays one channel at a time. Press the \blacktriangle arrow key to display the next channel. Press the \blacktriangledown arrow key to display the previous channel.

NOTE: Autoscan is disabled while in the bargraph home screen.

16.3 FILTER

The display filter can be used to slow down the amount of change to the misfire and detonation reference numbers that can occur from the constantly changing sensor input signal. Changing the filter value has a direct affect on output switch #1's reaction time. The rate of change is less for larger values. The filter value is read-out in a number from **1** to **255**, **1** being no filter value and **255** being maximum filter value. Misfire and detonation have their own separate filter settings. To set the filter value, use the \blacktriangle or \blacktriangledown arrow key to select either **DET** or **MIS**. Use the \blacktriangle or \blacktriangledown arrow keys to increase or decrease the filter value and press **ENTER** to save.

16.4 TIMING CONTROL

Use this menu to turn either the current loop control and/or the **Modbus** control **ON** or **OFF**, depending on which one is being used. Timing control on or off has no effect on the output switches.

16.5 CONTROL RPM VALUE

When the engine rpm is below the **Control RPM Value**, the **DET-1600** will act as a monitor only and will not activate the outputs. The range is **200 to 3000** rpm.

16.6 CONTROL LOCKOUT TIME

The **Control Lockout Time** is used to lock out (disable) the output switches, current loop, and **Modbus** control on start-up. Previous to timing out, the **DET-1600** will act as a monitor only and will not activate the outputs. This allows the engine to start and stabilize without the output switches or control interfering with engine start-up and loading. The timer starts when the **DET-1600** reaches the **Control RPM Value**. If the engine rpm goes below the **Control RPM Value** the timer resets. Enter a time from **0 to 999** seconds.

16.7 CONTROL METHOD

The **DET-1600** has two methods of controlling timing, current loop control and **Modbus** control. Select either **LOOP** or **MODBUS** and **ON** or **OFF**.

16.8 OUTPUT SWITCHES

The two output switches can be configured to **ACTIVE, YES or NO, FAIL-SAFE or SHELF STATE**, and **LATCHING or NONLATCHING**. For descriptions of these **SEE SECTIONS 8.5 AND 8.6**.

16.9 COMMUNICATIONS

The **DET-1600 Detonation Monitor** is part of a system that has been carefully designed to easily interface to popular computers, ignition systems, PLC's, and instruments. The serial communications are compliant to the **Modicon Modbus RTU** standard and uses **RS-485** for its hardware communication format. Two communication ports are available in the **DET-1600**, a master and a slave. Use the master port when the **DET-1600** is used to initiate the transactions, the slave when the **DET-1600** is used to respond to the requested data from a master. The **Modbus** master will be wired to the ignition system when the **DET-1600** is used to retard ignition timing. The **Modbus** slave will be wired to the PC or laptop when configuring and monitoring the **DET-1600**. To view or adjust the communication parameters, select **COMMUNICATIONS** from the menu and press **ENTER**. Select the node number from **01 to 99**. Select the baud rate. The following baud rates are available: **9600, 19200, 38400, 57600, and 115200**.

16.10 SECURITY

The security feature allows for protection from data inadvertently being changed. There are several areas in the menu system that can be protected as well as two layers of protection. The menus that can be protected are the **GENERAL SETTINGS**, the **SETPOINT VALUES**, and the ability to make **COMMUNICATIONS** setting changes. When protection is **ON**, the user is able to view the values in the menu but not able to change them. If an attempt is made to change the values the display will read **PASSWORD PROTECTED!**. The user must enter the proper password in the security menu to be able to make changes. If the correct password is entered, and protection is set to **OFF**, the requested values can be changed. To enter, set, or change a password, select **SECURITY** from the menu and press **ENTER**. Each of the areas (**GENERAL**, **SETPOINT**, and **COMMUNICATIONS**) can individually be turned on or off by using the **▲** or **▼** arrow keys. When an area is protected, the display will read **ON**, not protected will show as **OFF**. To enter a password, when in the security menu, press **SETUP**, **ENTER PASSWORD** will be displayed. Use the **▲** or **▼** arrow keys to increase or decrease each of the **3**-digit password numbers and press **ENTER**. Any number from **000 to 999** can be used.

NOTE: Autoscan, filter values, and reset cannot be locked out by security protection.

16.10.1 GENERAL

When set to **ON**, prevents the user from changing **TIMING CONTROL**, **CONTROL LOCKOUT TIME**, **CONTROL RPM**, **CONTROL METHOD**, and **OUTPUT SWITCHES**.

16.10.2 SETPOINT VALUES

When set to **ON**, prevents the user from changing the setpoint values. All setpoint values can be read but not changed.

16.10.3 COMMUNICATIONS

When set to **ON** prevents the user from changing the **Modbus** register data via the **Modbus** serial communications. The user can read data but not write data when communications protection is on. If the user attempts to perform a **Modbus** write, the error message **INVALID FUNCTION CODE** will be sent.

16.10.4 PASSWORD

A numerical password is the second level of protection. When **Set Security Password** is selected, the user will be prompted to enter a **3**-digit password. To enter a password, use the **▲** or **▼** arrow key to increase or decrease the underlined digit from **0 to 9** and press **ENTER**. The next digit will be underlined, use the same procedure to continue to enter a **3**-digit password and press **ENTER** to save. Any number from **000 to 999** can be used. When the password is set to **000**, no password will be required to make changes to the security screen.

With a password set, if an attempt is made to turn off any of the security bits in the security menu, the message **PASSWORD PROTECTED!** will appear. To allow changes, from the security menu press **SETUP** to access the password screen. If the proper password is entered, the user can turn off the security bits. Changes will now be allowed. If the incorrect password is entered, the display will show **PASSWORD INVALID** and continue to deny access to the protected menus.

17.0 VIEW ALARMS MENUS

The **VIEW ALARMS** menu allows the user to view the cause of shutdown and of any current fault diagnostic messages.

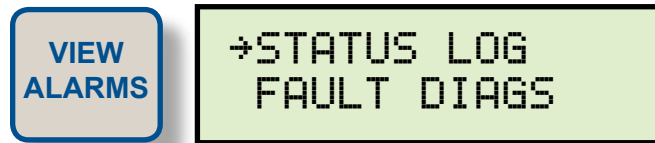

Pressing **VIEW ALARMS** brings up a **STATUS LOG and FAULT DIAGS** screen.

17.1 STATUS LOG

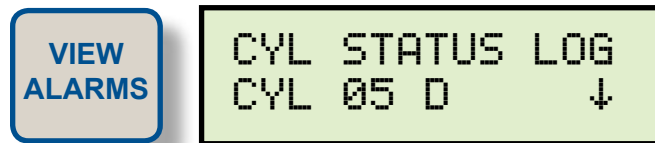

Selecting **STATUS LOG** displays the alarms that were occurring when switch #2 (the shutdown switch) tripped. The screen shows the cylinder number that caused the shutdown and **D**, **M**, or **S** for detonation, misfire, and bad sensor. Pressing the down arrow key ▼ will show the occurrences in the firing order. Each occurrence will appear once. After displaying all of the registered occurrences, the display will show **CLRLOG?**. Choose **YES** to clear the log or **NO** to retain the log. The display will revert back to the home screen. The logs are held in RAM only (volatile memory). If power is lost all past logs will be cleared. If no occurrences are logged, the display will show **CYL STATUS LOG/NONE**, press **ESC** to return to the home screen. Each time switch #2 trips a new set of status logs will be saved; the previous log messages will be overwritten with the new set.

17.2 FAULT DIAGNOSTICS

Fault Diagnostics are used as a troubleshooting aid. The following messages can be viewed if the **DET-1600** does not sense the required signal.

17.2.1 NO SD SIGNAL

Displayed when the **DET-1600** senses a lack of the shutdown lead voltage. Minimum voltage is **75** volts peak.

17.2.2 NO CYL #1

Displayed when the **DET-1600** senses a lack of the #1 coil primary voltage. Minimum voltage is **75** volts peak.

17.2.3 LOOP FAULT

Displayed if the current loop is activated and the loop wiring becomes disconnected, open or shorted.

17.2.4 COM TO IGN

Displayed if the **DET-1600** is configured to talk to an ignition system and communications is broken between the **RS485 Modbus Master** port and the ignition system.

17.2.5 INTRNL FAILURE

Displayed if an internal failure occurs. Cycle the power to clear. The fault diagnostic messages will automatically clear when the fault clears.

DET-1600 DETONATION SENSING MONITOR

17.3 RESET STATUS LOG

To clear the alarm log, press the **VIEW ALARMS** key and select the **CYLINDER STATUS LOG**. Press the down arrow key ▼ until the display shows **CLR LOG?**, select **YES** and press **ENTER**. The logs will be cleared. The **RESET** key does not clear the alarms. It does however reset the loop and clears the output switch(es) when set to latching mode.

18.0 RS-485 COMMUNICATIONS, MODBUS RTU

18.1 The **DET-1600** is compliant to the **Modicon Modbus RTU** standard. Maximum number of registers that can be read at one time is limited to **32**. Maximum number of booleans that can be read at one time is limited to **256**. The default configuration is **19200 baud, 8 Data bits, No Parity, 1 Stop bit (19200 8N1)**. The **MODBUS** address list is on the following pages.

Location	Label	0	1	Default	Notes
Read/Write bits					
00000's	Global Functions				
00001	Reserved				
00002	Ignition Timing Control Enabled	No	Yes	0	Enable/Disable Detonation Control, Revert to default timing
00003	Protect Configuration	Off	On	0	Protect general configuration from being changed
00004	Protect Setpoints	Off	On	0	Protect setpoint configuration from being changed
00005	Protect Comms	Off	On	0	Protect Communication configuration from being changed
00006	Switch 1 Enabled (1=on)	Off	On	0	
00007	Reserved				
00008	Switch 1 state (0=shelf 1=FS)	shelf	failsafe	0	switch 1 setup
00009	Switch 1 type (1=Latched)	non-latch	latch	0	switch 1 setup
00010	Switch 1 Trip on Diagnostics	Off	On	0	Allow switch 1 to activate if a fault diagnostic is flagged
00011	Switch 2 Enabled (1=on)	Off	On	0	switch 2
00012	Reserved				
00013	Switch 2 state (0=shelf 1=FS)	shelf	failsafe	0	switch 2 setup
00014	Switch 2 type (1=Latched)	non-latch	latch	0	switch 2 setup
00015	Reserved				
00016	External Ign timing Enabled	User value	External	0	
00017	Current Loop Ignition Control Enabled	Disabled	Enabled	0	
00018	Modbus Ignition Control Enabled	Disabled	Enabled	0	
00019	Display by tens mode	Disabled	Enabled	0	Displays reference numbers by tens
00020	Reserved				
00021	Reserved				
00023	Reserved				
00024	Reserved				
00025	Reserved				
00026	Reserved				
00027	Reserved				
00028	Reserved				
00029	Reserved				
00030	Reserved				
00031	Reserved				
00032	Reserved				

DET-1600 DETONATION SENSING MONITOR

Location	Input #	Individual Functions	0	1	Default	Notes
00033	1	Input is Enabled	No	Yes	1	
00034	2	Input is Enabled	No	Yes	1	
00035	3	Input is Enabled	No	Yes	1	
00036	4	Input is Enabled	No	Yes	1	
00037	5	Input is Enabled	No	Yes	1	
00038	6	Input is Enabled	No	Yes	1	
00039	7	Input is Enabled	No	Yes	1	
00040	8	Input is Enabled	No	Yes	1	
00041	9	Input is Enabled	No	Yes	1	
00042	10	Input is Enabled	No	Yes	1	
00043	11	Input is Enabled	No	Yes	1	
00044	12	Input is Enabled	No	Yes	1	
00045	13	Input is Enabled	No	Yes	1	
00046	14	Input is Enabled	No	Yes	1	
00047	15	Input is Enabled	No	Yes	1	
00048	16	Input is Enabled	No	Yes	1	

Location	Label	0	1	Notes
Read only bits				
10000's	Global Functions			
10001	Rotation Sensed	no rotation	rotation	The DET has sensed the engine is rotating. Use for loss of rotation
10002	Timing Control engaged	No	Yes	Ignition timing is being controlled by the DET
10003	Switch 1 Activated	No	Yes	Output switch 1 activated by detonation or misfire
10004	Switch 2 Activated	No	Yes	Output switch 2 activated by detonation
10005	Control RPM Achieved	below	above	Engine is below or above control RPM
10006	"G" Lead Signal Present	No	Yes	DET Diagnostics
10007	"#1 cyl" Signal Present	No	Yes	DET Diagnostics
10008	Ignition Communication Present	No	Yes	DET Diagnostics
10009	Factory Calibration R/W	Read only	Write	Factory Calibration Read/Write
10010	Watchdog	No	Yes	Self-Reliant Reset Function
10011	Reset Flag	No	Yes	
10012	Current Loop fault	No	Yes	
10013	Controls Locked Out	outputs active	outputs inactive	Controls are locked out during the Control Initialization time
10014	Alarms Present	no alarms	alarms	The Alarms Status registers contain valid (most recent Data)
10015	Invalid Window Parameter	OK	Window invalid	The Window open or close parameters are out of range
10016	Reserved			
	Individual Functions			
	Input #			
10017	Sensor Status	OK	Bad Sensor	Sensor is detected and operating properly or is not detected
10018	Sensor Status	OK	Bad Sensor	Sensor is detected and operating properly or is not detected
10019	Sensor Status	OK	Bad Sensor	Sensor is detected and operating properly or is not detected
10020	Sensor Status	OK	Bad Sensor	Sensor is detected and operating properly or is not detected
10021	Sensor Status	OK	Bad Sensor	Sensor is detected and operating properly or is not detected
10022	Sensor Status	OK	Bad Sensor	Sensor is detected and operating properly or is not detected
10023	Sensor Status	OK	Bad Sensor	Sensor is detected and operating properly or is not detected
10024	Sensor Status	OK	Bad Sensor	Sensor is detected and operating properly or is not detected
10025	Sensor Status	OK	Bad Sensor	Sensor is detected and operating properly or is not detected
10026	Sensor Status	OK	Bad Sensor	Sensor is detected and operating properly or is not detected

DET-1600 DETONATION SENSING MONITOR

Location	Input #	Individual Functions	0	1	Notes
10027	11	Sensor Status	OK	Bad Sensor	Sensor is detected and operating properly or is not detected
10028	12	Sensor Status	OK	Bad Sensor	Sensor is detected and operating properly or is not detected
10029	13	Sensor Status	OK	Bad Sensor	Sensor is detected and operating properly or is not detected
10030	14	Sensor Status	OK	Bad Sensor	Sensor is detected and operating properly or is not detected
10031	15	Sensor Status	OK	Bad Sensor	Sensor is detected and operating properly or is not detected
10032	16	Sensor Status	OK	Bad Sensor	Sensor is detected and operating properly or is not detected
10033	1	Detonation Detected Status	OK	detonation detected	Detonation detected on this channel
10034	2	Detonation Detected Status	OK	detonation detected	Detonation detected on this channel
10035	3	Detonation Detected Status	OK	detonation detected	Detonation detected on this channel
10036	4	Detonation Detected Status	OK	detonation detected	Detonation detected on this channel
10037	5	Detonation Detected Status	OK	detonation detected	Detonation detected on this channel
10038	6	Detonation Detected Status	OK	detonation detected	Detonation detected on this channel
10039	7	Detonation Detected Status	OK	detonation detected	Detonation detected on this channel
10040	8	Detonation Detected Status	OK	detonation detected	Detonation detected on this channel
10041	9	Detonation Detected Status	OK	detonation detected	Detonation detected on this channel
10042	10	Detonation Detected Status	OK	detonation detected	Detonation detected on this channel
10043	11	Detonation Detected Status	OK	detonation detected	Detonation detected on this channel
10044	12	Detonation Detected Status	OK	detonation detected	Detonation detected on this channel
10045	13	Detonation Detected Status	OK	detonation detected	Detonation detected on this channel
10046	14	Detonation Detected Status	OK	detonation detected	Detonation detected on this channel
10047	15	Detonation Detected Status	OK	detonation detected	Detonation detected on this channel
10048	16	Detonation Detected Status	OK	detonation detected	Detonation detected on this channel
10049	1	Misfire Detected Status	OK	misfire detected	Misfire detected on this channel
10050	2	Misfire Detected Status	OK	misfire detected	Misfire detected on this channel
10051	3	Misfire Detected Status	OK	misfire detected	Misfire detected on this channel
10052	4	Misfire Detected Status	OK	misfire detected	Misfire detected on this channel
10053	5	Misfire Detected Status	OK	misfire detected	Misfire detected on this channel
10054	6	Misfire Detected Status	OK	misfire detected	Misfire detected on this channel
10055	7	Misfire Detected Status	OK	misfire detected	Misfire detected on this channel
10056	8	Misfire Detected Status	OK	misfire detected	Misfire detected on this channel
10057	9	Misfire Detected Status	OK	misfire detected	Misfire detected on this channel

Location	Input #	Individual Functions	0	1	Notes
10058	10	Misfire Detected Status	OK	misfire detected	Misfire detected on this channel
10059	11	Misfire Detected Status	OK	misfire detected	Misfire detected on this channel
10060	12	Misfire Detected Status	OK	misfire detected	Misfire detected on this channel
10061	13	Misfire Detected Status	OK	misfire detected	Misfire detected on this channel
10062	14	Misfire Detected Status	OK	misfire detected	Misfire detected on this channel
10063	15	Misfire Detected Status	OK	misfire detected	Misfire detected on this channel
10064	16	Misfire Detected Status	OK	misfire detected	Misfire detected on this channel
10065	1	Sensor Status @ 'SW2'	OK	Bad Sensor	Sensor Status at SW2 trip
10066	2	Sensor Status @ 'SW2'	OK	Bad Sensor	Sensor Status at SW2 trip
10067	3	Sensor Status @ 'SW2'	OK	Bad Sensor	Sensor Status at SW2 trip
10068	4	Sensor Status @ 'SW2'	OK	Bad Sensor	Sensor Status at SW2 trip
10069	5	Sensor Status @ 'SW2'	OK	Bad Sensor	Sensor Status at SW2 trip
10070	6	Sensor Status @ 'SW2'	OK	Bad Sensor	Sensor Status at SW2 trip
10071	7	Sensor Status @ 'SW2'	OK	Bad Sensor	Sensor Status at SW2 trip
10072	8	Sensor Status @ 'SW2'	OK	Bad Sensor	Sensor Status at SW2 trip
10073	9	Sensor Status @ 'SW2'	OK	Bad Sensor	Sensor Status at SW2 trip
10074	10	Sensor Status @ 'SW2'	OK	Bad Sensor	Sensor Status at SW2 trip
10075	11	Sensor Status @ 'SW2'	OK	Bad Sensor	Sensor Status at SW2 trip
10076	12	Sensor Status @ 'SW2'	OK	Bad Sensor	Sensor Status at SW2 trip
10077	13	Sensor Status @ 'SW2'	OK	Bad Sensor	Sensor Status at SW2 trip
10078	14	Sensor Status @ 'SW2'	OK	Bad Sensor	Sensor Status at SW2 trip
10079	15	Sensor Status @ 'SW2'	OK	Bad Sensor	Sensor Status at SW2 trip
10080	16	Sensor Status @ 'SW2'	OK	Bad Sensor	Sensor Status at SW2 trip
10081	1	Detonation Status @ 'SW2'	OK	detonation detected	latched Detonation Status on this channel at "SW2 "
10082	2	Detonation Status @ 'SW2'	OK	detonation detected	latched Detonation Status on this channel at "SW2 "
10083	3	Detonation Status @ 'SW2'	OK	detonation detected	latched Detonation Status on this channel at "SW2 "
10084	4	Detonation Status @ 'SW2'	OK	detonation detected	latched Detonation Status on this channel at "SW2 "
10085	5	Detonation Status @ 'SW2'	OK	detonation detected	latched Detonation Status on this channel at "SW2 "
10086	6	Detonation Status @ 'SW2'	OK	detonation detected	latched Detonation Status on this channel at "SW2 "
10087	7	Detonation Status @ 'SW2'	OK	detonation detected	latched Detonation Status on this channel at "SW2 "
10088	8	Detonation Status @ 'SW2'	OK	detonation detected	latched Detonation Status on this channel at "SW2 "

DET-1600 DETONATION SENSING MONITOR

Location	Input #	Individual Functions	0	1	Notes
10089	9	Detonation Status @ 'SW2'	OK	detonation detected	latched Detonation Status on this channel at "SW2 "
10090	10	Detonation Status @ 'SW2'	OK	detonation detected	latched Detonation Status on this channel at "SW2 "
10091	11	Detonation Status @ 'SW2'	OK	detonation detected	latched Detonation Status on this channel at "SW2 "
10092	12	Detonation Status @ 'SW2'	OK	detonation detected	latched Detonation Status on this channel at "SW2 "
10093	13	Detonation Status @ 'SW2'	OK	detonation detected	latched Detonation Status on this channel at "SW2 "
10094	14	Detonation Status @ 'SW2'	OK	detonation detected	latched Detonation Status on this channel at "SW2 "
10095	15	Detonation Status @ 'SW2'	OK	detonation detected	latched Detonation Status on this channel at "SW2 "
10096	16	Detonation Status @ 'SW2'	OK	detonation detected	latched Detonation Status on this channel at "SW2 "
10097	1	Misfire status @ 'SW2'	OK	misfire detected	latched Misfire status on this channel at 'SW2'
10098	2	Misfire status @ 'SW2'	OK	misfire detected	latched Misfire status on this channel at 'SW2'
10099	3	Misfire status @ 'SW2'	OK	misfire detected	latched Misfire status on this channel at 'SW2'
10100	4	Misfire status @ 'SW2'	OK	misfire detected	latched Misfire status on this channel at 'SW2'
10101	5	Misfire status @ 'SW2'	OK	misfire detected	latched Misfire status on this channel at 'SW2'
10102	6	Misfire status @ 'SW2'	OK	misfire detected	latched Misfire status on this channel at 'SW2'
10103	7	Misfire status @ 'SW2'	OK	misfire detected	latched Misfire status on this channel at 'SW2'
10104	8	Misfire status @ 'SW2'	OK	misfire detected	latched Misfire status on this channel at 'SW2'
10105	9	Misfire status @ 'SW2'	OK	misfire detected	latched Misfire status on this channel at 'SW2'
10106	10	Misfire status @ 'SW2'	OK	misfire detected	latched Misfire status on this channel at 'SW2'
10107	11	Misfire status @ 'SW2'	OK	misfire detected	latched Misfire status on this channel at 'SW2'
10108	12	Misfire status @ 'SW2'	OK	misfire detected	latched Misfire status on this channel at 'SW2'
10109	13	Misfire status @ 'SW2'	OK	misfire detected	latched Misfire status on this channel at 'SW2'
10110	14	Misfire status @ 'SW2'	OK	misfire detected	latched Misfire status on this channel at 'SW2'
10111	15	Misfire status @ 'SW2'	OK	misfire detected	latched Misfire status on this channel at 'SW2'
10112	16	Misfire status @ 'SW2'	OK	misfire detected	latched Misfire status on this channel at 'SW2'

Location	Label	Units	Size(bits)	Min	Max	Notes
<i>Read only bytes</i>						
30000's						
Global Functions						
30001	Same as 10001-10016					
30002	Same as 10017-10032					Bad Sensor Status Flags
30003	Same as 10033-10048					Detonation Status Flags
30004	Same as 10049-10064					Misfire Status Flags
30005	Same as 10065-10080					Alarms Bad Sensor Status Flags
30006	Same as 10081-10096					Alarms Detonation Status Flags
30007	Same as 10097-10112					Alarms Misfire Status Flags
30008	Same as 10113-10128					
30009	Default timing from Ignition System	degrees	16	0	90	The Spark timing value from the Ignition System
30010	Supply Voltage (1234=12.34 V)	volts	16	0	--	Voltage measured at supply terminals
30011	Calculated Engine RPM	RPM	16	0	3600	
30012	Average Misfire Level	--	16	0	1023	
30013	Average Detonation Level	--	16	0	1023	
30014	Reserved					
Individual Functions						
	Input #					
30015	1 Misfire Level	--	16	0	1023	
30016	2 Misfire Level	--	16	0	1023	
30017	3 Misfire Level	--	16	0	1023	
30018	4 Misfire Level	--	16	0	1023	
30019	5 Misfire Level	--	16	0	1023	
30020	6 Misfire Level	--	16	0	1023	
30021	7 Misfire Level	--	16	0	1023	
30022	8 Misfire Level	--	16	0	1023	
30023	9 Misfire Level	--	16	0	1023	
30024	10 Misfire Level	--	16	0	1023	

DET-1600 DETONATION SENSING MONITOR

Location	Input #	Individual Functions	Units	Size(bits)	Min	Max	Notes
30025	11	Misfire Level	--	16	0	1023	
30026	12	Misfire Level	--	16	0	1023	
30027	13	Misfire Level	--	16	0	1023	
30028	14	Misfire Level	--	16	0	1023	
30029	15	Misfire Level	--	16	0	1023	
30030	16	Misfire Level	--	16	0	1023	
30031	1	Detonation Level	--	16	0	1023	
30032	2	Detonation Level	--	16	0	1023	
30033	3	Detonation Level	--	16	0	1023	
30034	4	Detonation Level	--	16	0	1023	
30035	5	Detonation Level	--	16	0	1023	
30036	6	Detonation Level	--	16	0	1023	
30037	7	Detonation Level	--	16	0	1023	
30038	8	Detonation Level	--	16	0	1023	
30039	9	Detonation Level	--	16	0	1023	
30040	10	Detonation Level	--	16	0	1023	
30041	11	Detonation Level	--	16	0	1023	
30042	12	Detonation Level	--	16	0	1023	
30043	13	Detonation Level	--	16	0	1023	
30044	14	Detonation Level	--	16	0	1023	
30045	15	Detonation Level	--	16	0	1023	
30046	16	Detonation Level	--	16	0	1023	
30047	1	Retard from default timing	degrees	16	0	90	Default timing is set by Ignition system
30048	2	Retard from default timing	degrees	16	0	90	Default timing is set by Ignition system
30049	3	Retard from default timing	degrees	16	0	90	Default timing is set by Ignition system
30050	4	Retard from default timing	degrees	16	0	90	Default timing is set by Ignition system
30051	5	Retard from default timing	degrees	16	0	90	Default timing is set by Ignition system
30052	6	Retard from default timing	degrees	16	0	90	Default timing is set by Ignition system

Location	Input #	Individual Functions	Units	Size(bits)	Min	Max	Notes
30053	7	Retard from default timing	degrees	16	0	90	Default timing is set by Ignition system
30054	8	Retard from default timing	degrees	16	0	90	Default timing is set by Ignition system
30055	9	Retard from default timing	degrees	16	0	90	Default timing is set by Ignition system
30056	10	Retard from default timing	degrees	16	0	90	Default timing is set by Ignition system
30057	11	Retard from default timing	degrees	16	0	90	Default timing is set by Ignition system
30058	12	Retard from default timing	degrees	16	0	90	Default timing is set by Ignition system
30059	13	Retard from default timing	degrees	16	0	90	Default timing is set by Ignition system
30060	14	Retard from default timing	degrees	16	0	90	Default timing is set by Ignition system
30061	15	Retard from default timing	degrees	16	0	90	Default timing is set by Ignition system
30062	16	Retard from default timing	degrees	16	0	90	Default timing is set by Ignition system
30063	—	Direct Hi Trip Setpoint Flags	binary	16	0	65535	Cylinders 1 to 16

DET-1600 DETONATION SENSING MONITOR

Location	Label	Units	Size (bits)	Min	Max	Default	Notes
Read/Write bytes							
40000's	Global Functions						
40001	Coils 001-016	--	16	0	65535	0	
40002	Coils 017-032	--	16	0	65535	0	
40003	Coils 033-048	--	16	0	65535	65535	Inputs Enabled
40004	Coils 049-064	--	16	0	65535	0	
40005	Coils 065-080	--	16	0	65535	0	
40006	Coils 081-096	--	16	0	65535	0	
40007	Coils 097-112	--	16	0	65535	0	
40008	Coils 113-128	--	16	0	65535	0	
40009	Auto Scan (1 to 30 sec.)	seconds	16	0	30	0	0=off, 1-30 sec.
40010	Node Number (1-99)	--	16	1	99	1	
40011	Baud Rate (0=9.6K, 1=19.2K,...)	bits/sec	16			19.2K	0=9.6K, 1=19.2K, 2=38.4K, 3=57.6K, 4=115.2K
40012	Security Password (000 - 999)		16	000	999	000	
40013	Det Lag Filter Gain Value (1-255)	--	16	1	255	240	
40014	Number of Cylinders (1-16)	--	16	1	16	6	
40015	2 or 4 cycle	--	16	2	4	4	
40016	Misfire Lag Filter Gain Value (1-255)	--	16	1	255	240	
40017	Number of sensors used (1-16)	--	16	1	16	6	
40018	Control RPM value (200-3000)	RPM	16	200	3000	900	RPM value where DET is able to adjust timing
40019	Open Misfire Window	degrees	16	1	90	20	In degrees from firing.
40020	Duration of Misfire Window	degrees	16	1	90	10	In degrees from opening of misfire window
40021	Open Detonation Window	degrees	16	1	90	20	In degrees from firing.
40022	Duration of Detonation Window	degrees	16	1	90	10	In degrees from opening of detonation window
40023	Misfire Setpoint Value (SW1)	--	16	0	1023	300	

Location	Label	Units	Size (bits)	Min	Max	Default	Notes
40024	Switch 1 Hysteresis time	seconds	16	0	999	3	
40025	DET Setpoint Value (SW1)	-	16	0	1023	800	
40026	Switch 2 Time until Tripped	seconds	16	0	999	3	
40027	Control Initialization Time	seconds	16	1	999	1	
40028	Current Loop Hi (20mA)	"degrees Retard"	16	0	90	24	"CD200 - 4mA = 16° retard, 20mA = 0° retard CPU95 - 4mA = 0° retard, 20mA = 48° retard (A code) CPU95 - 4mA = 0° retard, 20mA = 36° retard (B code) CPU95 - 4mA = 0° retard, 20mA = 24° retard (C code) DISN800 - 4mA = 8° retard, 20mA = 0° retard"
40029	Current Loop Lo (4mA)	"degrees Retard"	16	0	90	0	
40030	Current Loop Cal 20mA (AD Counts)	Counts	16	0	65535	54613	
40031	Current Loop Cal 4mA (AD Counts)	Counts	16	0	65535	10923	
40032	Ignition Timing BTDC (user input value)	degrees	16	0	90	32	In degrees before TDC. Ignored if external ignition timing flag set.
40033	Max Retard timing value allowed	degrees	16	0	90	24	
40034	Retard step value (1-10)	degrees	16	0	10	1	step value to retard when detecting detonation
40035	Advance step value (1-10)	degrees	16	0	10	1	step value to advance when previously retarded and no detonation is present
40036	Time (sec.) Between Retard Steps	seconds	16	0	999	2	Detonation must exceed set level for this long before taking action
40037	Time (sec.) Between Advance Steps	seconds	16	0	999	10	The absence of detonation must exceed set level for this long before taking action
40038	Direct HI Trip Setpoint	-	16	500	1024	1024	Bypasses ignition retard, 1024 = Off
40039	External Ignition Modbus Timing Location	-	16	30001	30999	30006	External Ignition's Modbus register location for engine timing
40040	Bad Sensor Setpoint	-	16	1	1023	50	MF or DET levels below this setpoint will indicate a bad/missing sensor
40041	Timing Retard Register (Ignition)	-	16	40001	40999	40007	
40042	Default Ignition Timing (° Retard)	-	16	0	900	0	
40043	Ignition Node ID	-	16	1	99	2	
40044	Ignition Baud Rate	-	16	0	4	0	0=9.6K, 1=19.2K, 2=38.4K, 3=57.6K, 4=115.2K
40045	Reserved	-	16				
40046	Reserved	-	16				
40047	Reserved	-	16				
40048	Reserved	-	16				
40049	Reserved	-	16				

DET-1600 DETONATION SENSING MONITOR

Location	Input #	Individual Functions	Units	Size (bits)	Min	Max	Default	Notes
40050	1	Factory						
40051	1	misfire gain (0-63)	-	16	0	63	14	
40052	1	misfire bandpass filter freq. (0-63)	-	16	0	63	35	
40053	1	misfire Integrator time constant (0-31)	-	16	0	31	26	
40054	1	detonation gain (0-63)	-	16	0	63	14	
40055	1	detonation bandpass freq. (0-63)	-	16	0	63	35	
40056	1	detonation Integrator time constant (0-31)	--	16	0	31	26	
40057	1	Reserved	--	16				
40058	1	Reserved		16				
40059	1	Reserved		16				
40060	1	Misfire Normalization Offset	-	16	-500	500	0	Offset Value to Normalize the Misfire Level
40061	1	Detonation Normalization Offset	-	16	-500	500	0	Offset Value to Normalize the Detonation Level
40062	1	Reserved		16				
40063	1	Reserved		16				
40064	1	Cylinder Label (XX)	-	16	0	65355	"XX"	Two ASCII characters
40065	1	Sensor Number (1-16)	-	16	1	16	firing event	
40066	1	Reserved		16				
40067	1	Reserved		16				
40068	1	Reserved		16				
40069	1	Reserved		16				
40370	1	Key Command Register	-	16	0	65535	0	Used for special commands, momentary
40371	1	Reserved		16				
KEY COMMANDS								
Value Function								
64260	Clears the "Alarms Present Flag"						Momentary	
64515	Perform a control reset						Momentary	

Firing Event	Starting Location
1	40050
2	40070
3	40090
4	40110
5	40130
6	40150
7	40170
8	40190
9	40210
10	40230
11	40250
12	40270
13	40290
14	40310
15	40330
16	40350

FIRING EVENT 16								
Location	Firing event #	Label	Units	Size (bits)	Min	Max	Default	Notes
40350	16	Factory						
40351	16	misfire gain (0-63)	--	16	0	63	14	SEE GAIN CHART, PAGE 56
40352	16	misfire bandpass filter freq. (0-63)	--	16	0	63	35	SEE BANDPASS CHART, PAGE 56
40353	16	misfire Integrator time constant (0-31)	--	16	0	31	26	SEE INTEGRATOR CHART, PAGE 57
40354	16	detonation gain (0-63)	--	16	0	63	14	SEE GAIN CHART, PAGE 56
40355	16	detonation bandpass freq. (0-63)	--	16	0	63	35	SEE BANDPASS CHART, PAGE 56
40356	16	detonation Integrator time constant (0-31)	--	16	0	31	26	SEE INTEGRATOR CHART, PAGE 57
40357	16	Reserved	--	16	0	0	0	MF or DET levels below this setpoint will indicate a bad/missing sensor
40358	16	Reserved	0	16	0	0	0	0
40359	16	Reserved	0	16	0	0	0	0
40360	16	Misfire Normalization Offset	--	16	-500	500	0	Offset Value to Normalize the Misfire Level
40361	16	Detonation Normalization Offset	--	16	-500	500	0	Offset Value to Normalize the Detonation Level
40362	16	Reserved	0	16	0	0	0	0
40363	16	Reserved	0	16	0	0	0	0
40364	16	Cylinder Label (XX)	--	16	0	65355	"XX"	Two ASCII characters
40365	16	Sensor Number (1-16)	--	16	1	16	16	0
40366	16	Reserved	0	16	0	0	0	0
40367	16	Reserved	0	16	0	0	0	0
40368	16	Reserved	0	16	0	0	0	0
40369	16	Reserved	0	16	0	0	0	0

DET-1600 DETONATION SENSING MONITOR

GAIN CHART (Registers 40351 and 40354)

Register Value	Gain	Register Value	Gain
0	2.000	44	0.258
1	1.882	45	0.250
2	1.778	46	0.236
3	1.684	47	0.222
4	1.600	48	0.211
5	1.523	49	0.200
6	1.455	50	0.190
7	1.391	51	0.182
8	1.333	52	0.174
9	1.280	53	0.167
10	1.231	54	0.160
11	1.185	55	0.154
12	1.143	56	0.148
13	1.063	57	0.143
14	1.000	58	0.138
15	0.944	59	0.133
16	0.895	60	0.129
17	0.850	61	0.125
18	0.810	62	0.118
19	0.773	63	0.111
20	0.739		
21	0.708		
22	0.680		
23	0.654		
24	0.630		
25	0.607		
26	0.586		
27	0.567		
28	0.548		
29	0.500		
30	0.471		
31	0.444		
32	0.421		
33	0.400		
34	0.381		
35	0.364		
36	0.348		
37	0.333		
38	0.320		
39	0.308		
40	0.296		
41	0.286		
42	0.276		
43	0.267		

BANDPASS CHART (Registers 40352 and 40355)

Register Value	Bandpass Filter Freq.	Register Value	Bandpass Filter Freq.
0	1.220 kHz	44	8.020 kHz
1	1.260 kHz	45	8.460 kHz
2	1.310 kHz	46	8.950 kHz
3	1.350 kHz	47	9.500 kHz
4	1.400 kHz	48	10.120 kHz
5	1.450 kHz	49	10.460 kHz
6	1.510 kHz	50	10.830 kHz
7	1.570 kHz	51	11.220 kHz
8	1.630 kHz	52	11.650 kHz
9	1.710 kHz	53	12.100 kHz
10	1.780 kHz	54	12.600 kHz
11	1.870 kHz	55	13.140 kHz
12	1.960 kHz	56	13.720 kHz
13	2.070 kHz	57	14.360 kHz
14	2.180 kHz	58	15.070 kHz
15	2.310 kHz	59	15.840 kHz
16	2.460 kHz	60	16.710 kHz
17	2.540 kHz	61	17.670 kHz
18	2.620 kHz	62	18.760 kHz
19	2.710 kHz	63	19.980 kHz
20	2.810 kHz		
21	2.920 kHz		
22	3.030 kHz		
23	3.150 kHz		
24	3.280 kHz		
25	3.430 kHz		
26	3.590 kHz		
27	3.760 kHz		
28	3.950 kHz		
29	4.160 kHz		
30	4.390 kHz		
31	4.660 kHz		
32	4.950 kHz		
33	5.120 kHz		
34	5.290 kHz		
35	5.480 kHz		
36	5.680 kHz		
37	5.900 kHz		
38	6.120 kHz		
39	6.370 kHz		
40	6.640 kHz		
41	6.940 kHz		
42	7.270 kHz		
43	7.630 kHz		

INTEGRATOR CHART (Registers 40353 and 40356)

Register Value	Integrator Time Const
0	40
1	45
2	50
3	55
4	60
5	65
6	70
7	75
8	80
9	90
10	100
11	110
12	120
13	130
14	140
15	150
16	160
17	180
18	200
19	220
20	240
21	260
22	280
23	300
24	320
25	360
26	400
27	440
28	480
29	520
30	560
31	600

GLOSSARY:

TDC Top Dead Center - The highest piston position, where the piston turns and moves back down.

°btdc..... Engine degrees Before Top Dead Center.

°atdc..... Engine degrees After Top Dead Center.

Fire Event From 1 to x in numerical order of the engine firing order.

Engine firing order..... The engine cylinder firing sequence.

normal run timing value... The timing value in °btdc that the engine runs at with normal loads. This is the max advanced timing value and the **DET-1600** can only retard the engine timing from this value.

DET-1600 DETONATION SENSING MONITOR

FIGURES SECTION:

- 1. MOUNTING DIMENSIONS AND SPECIFICATIONS**
- 2. FLOWCHART**
- 3. HOME SCREENS**
- 4. MOUNTING, DIMENSIONS, AND SPECS – KNOCK SENSORS**
- 5. WIRING DIAGRAM – DETONATION SENSORS**
- 6. WIRING DIAGRAM – POWER, INPUTS, AND OUTPUTS**
- 7. WIRING DIAGRAM – MODBUS CONTROL TO IGNITION SYSTEM**
- 8. WIRING DIAGRAM – CURRENT LOOP, CPU-95**
- 9. WIRING DIAGRAM – CURRENT LOOP, CD200/DISN**
- 10. WIRING DIAGRAM – ALTRONIC ANNUNCIATOR SYSTEMS**
- 11. WIRING DIAGRAM – DC RELAYS**
- 12. WIRING DIAGRAM – RS-485 COMMUNICATIONS, PC HOOK-UP**

FIGURE 1. MOUNTING DIMENSIONS AND SPECIFICATIONS

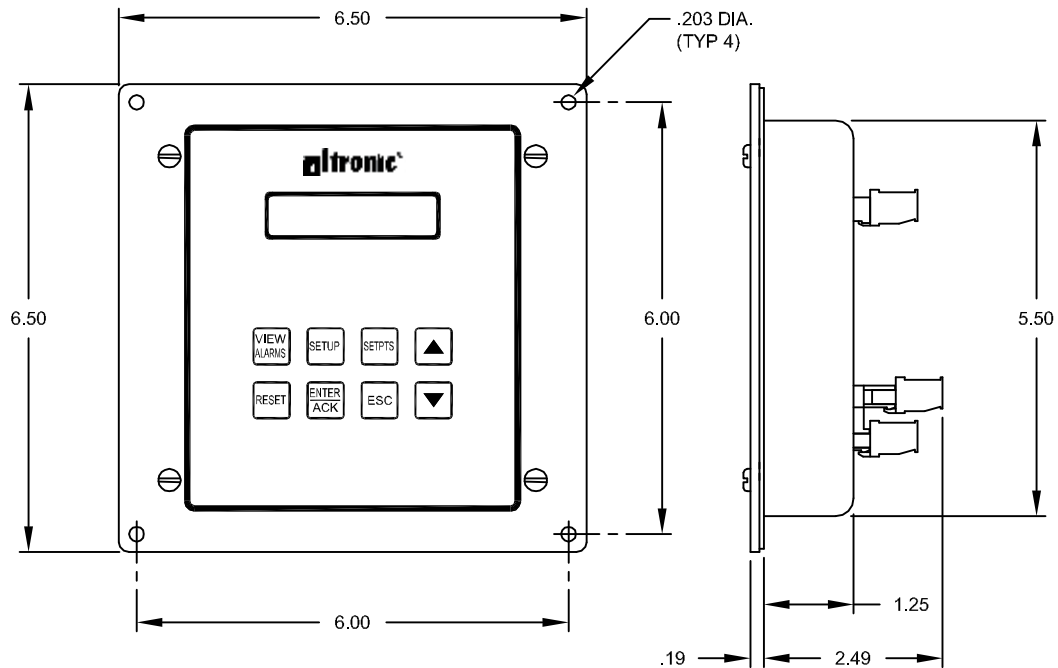

SPECIFICATIONS:

POWER REQUIRED: DC POWERED 10-32 VDC, 0.30 AMP. MAX.

AMBIENT TEMPERATURE RANGE: -40° TO 85°C (-40° TO 185°F).

SENSORS: UP TO 16.

SENSOR TYPE: PIEZOELECTRIC VIBRATION SENSOR; BOSCH 0 261 231 148 OR EQUIVALENT.

KEYPAD: 8-KEY MEMBRANE KEYPAD.

DISPLAY: BACKLIT 2 X 16 LCD CHARACTER.

DISPLAY UPDATE RATE: 0.5 SECONDS NOMINAL.

SENSOR SCAN RATE: ON FIRING EVENT.

OUTPUT SWITCH: TWO PROGRAMMABLE SOLID STATE SWITCHES
 RATED 200 VDC, 0.2 AMP CONTINUOUS, OPTICALLY ISOLATED
 FROM POWER SUPPLY. ONE FOR ALARM, ONE FOR SHUTDOWN.

SWITCH RESPONSE TIME: TIED TO FILTER VALUE AND DISPLAY READING (WITH FILTER AT 1
 MAX RESPONSE TIME IS APPROXIMATELY 0.5 SECONDS).

RS485 SERIAL OUTPUTS: 1 MASTER, 1 SLAVE.

CURRENT LOOP OUTPUT: 4-20mA.

HAZARDOUS AREA CLASSIFICATION: CLASS I, DIV. 2, GROUPS C & D FOR DIRECT HOOK-UP
 TEMP CODE T4. MAX. AMBIENT TEMP. 85°C.

DET-1600 DETONATION SENSING MONITOR

FIGURE 2. FLOWCHART

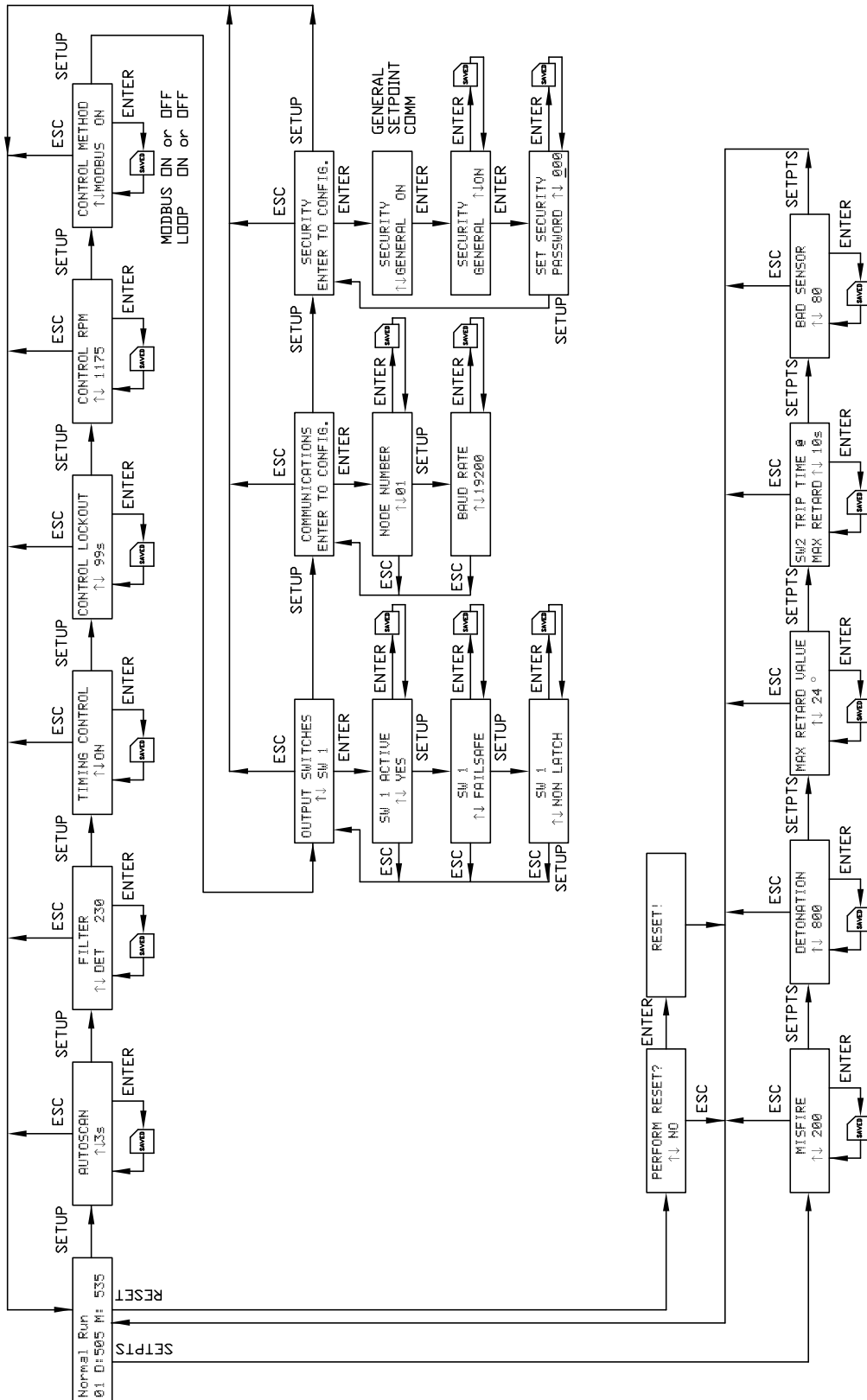
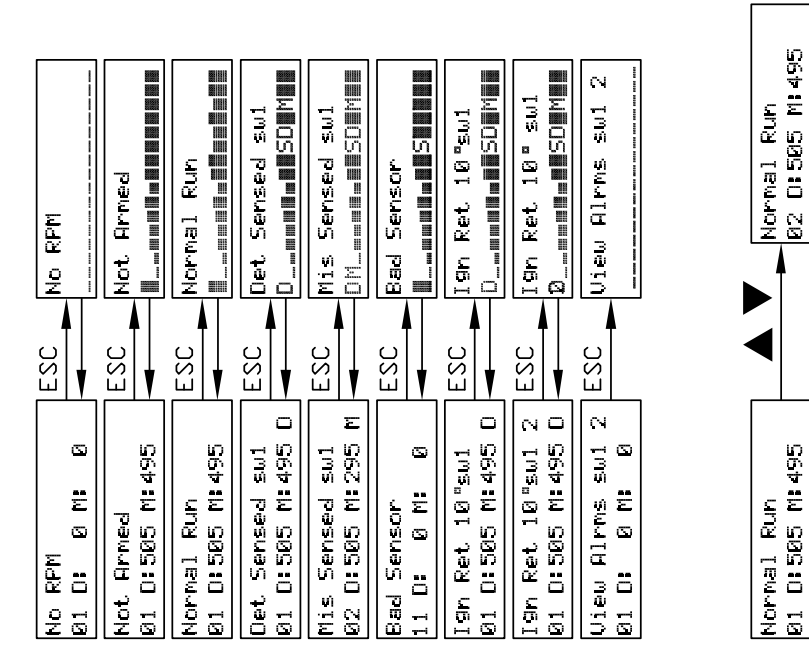

FIGURE 3. HOME SCREENS



CONDITION

NO ENGINE ROTATION

CONTROL RPM HAS NOT BEEN MET OR CONTROL LOCKOUT TIME HAS NOT ELAPSED

NORMAL OPERATION, OUTPUTS CAN BE ACTIVATED

LOAD SWITCH 1 IS TRIPPED, DETONATION OCCURRING ON CYL XX

WHEN DETONATION OR MISFIRE OCCURS, D OR M IS DISPLAYED, D OR M IS SHOWN ONLY ON CORRESPONDING CYL SCREEN(S).

A SENSOR IS OPEN OR SHORTED.

LOOP CURRENT OR MODBUS TO IGNITION TO RETARD TIMING

AS ABOVE WITH ADDITION OF SHUTDOWN SWITCH 2 TRIPPED

WHEN SWITCH 2 TRIPS THE CYLINDER THAT CAUSED THE SHUTDOWN AND ITS DATA IS RECORDED. PRESS VIEW ALARMS KEY TO ACCESS THE SHUTDOWN LOG.

UP ARROW TO NEXT CHANNEL IN FIRING ORDER.
DOWN ARROW TO PREVIOUS CHANNEL IN FIRING ORDER.
VIEW ONLY CONFIGURED CHANNELS.

- NOTES:
1. "sw1" FOLLOWS SWITCH 1
 2. "sw2" FOLLOWS SWITCH 2
 3. - (DISABLED), D (DETONATION), M (MISFIRE), AND S (BAD SENSOR) ARE PER CHANNEL. PRIORITY IS -, D, M, S
 4. VIEW ALARMS BLINKS ON FIRST LINE ON THE TOP ROW AT 1 SEC INTERVAL UNTIL IT IS ACKNOWLEDGED BY PRESSING ENTER/ACK.

DET-1600 DETONATION SENSING MONITOR

FIGURE 4. MOUNTING, DIMENSIONS, AND SPECS – KNOCK SENSORS

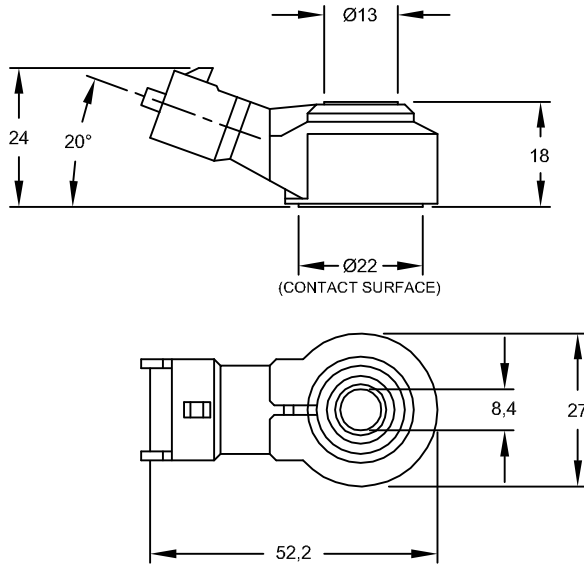

NOTE: DIMENSIONS ARE IN MILLIMETERS.

SPECIFICATIONS:

FREQUENCY RANGE: 1-20kHz

MEASURING RANGE: 0.1 - 400 g

SENSITIVITY AT 5 kHz: 26 ± 8 mV/g

OPERATING TEMPERATURE RANGE: -40°C - +150°C

INSTALLATION:

MOUNTING BOLT: GREY CAST IRON: M8 X 25; GRADE 8.8
ALUMINUM: M8 X 30; GRADE 8.8

TIGHTENING TORQUE (OILED PERMITTED): 20 ± 5 N/m; 15 ± 1 Ft/Lb

MOUNTING POSITION: ARBITRARY

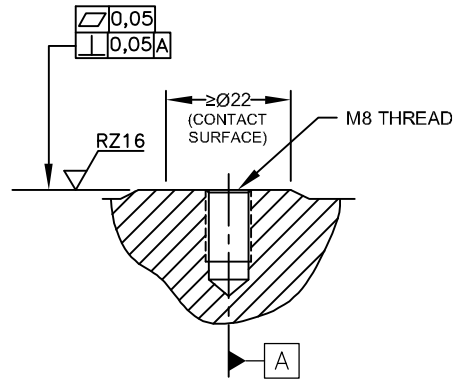

MOUNTING HOLE

INSTALLATION INSTRUCTIONS:

MOUNT THE DETONATION SENSORS TO A SMOOTH SURFACE (COUNTERBORE IF NECESSARY) ON THE ENGINE CRANKCASE JUST BELOW THE CYLINDER HEAD, A SURFACE THAT IS NOT SMOOTH WILL GIVE ERRATIC READINGS. THE SENSORS SHOULD BE AS SYMMETRIC AS POSSIBLE. ANGULAR MOUNTING POSITION IS ARBITRARY. DRILL AND TAP THE BLOCK PERPENDICULAR TO THE SURFACE, TAKE CARE NOT TO PENETRATE THE WATER JACKET.

FIGURE 5. WIRING DIAGRAM - DETONATION SENSORS

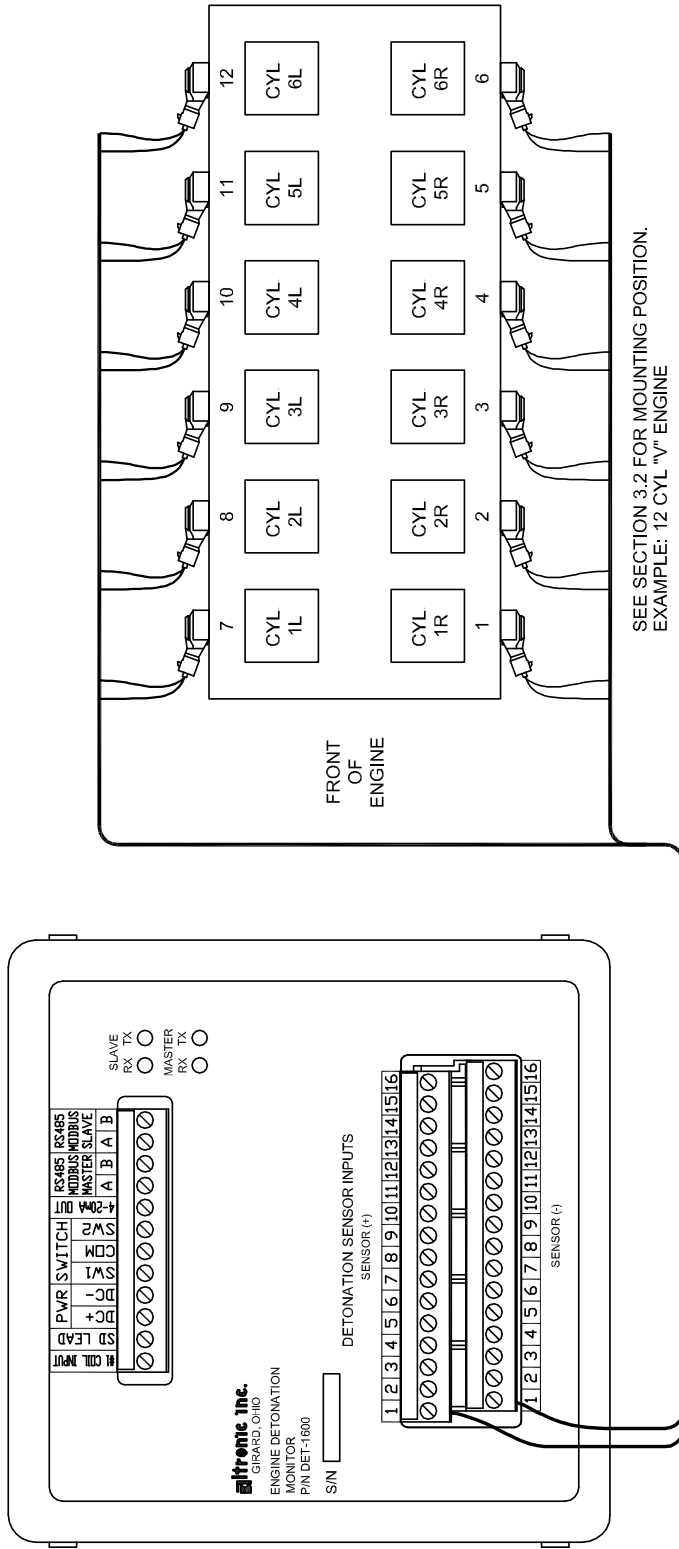

WIRE SENSOR TO BACK OF DET-1600 IN FIRING ORDER OF ENGINE STARTING WITH CYLINDER #1

FIRE EVENT & TERMINAL # ON BACK OF DET-1600	1	2	3	4	5	6	7	8	9	10	11	12
FIRING ORDER V-ENGINE	1R	6L	5R	2L	3R	4L	6R	1L	2R	5L	4R	3L
SENSOR #	1	12	5	8	3	10	6	7	2	11	4	9

EXAMPLE:
12 CYL. "V" ENGINE

FIRE EVENT & TERMINAL # ON BACK OF DET-1600	1	2	3	4	5	6	7	8	9	10	11	12	13	14	15	16
FIRING ORDER V-ENGINE																
FIRING ORDER IN-LINE ENGINE																
SENSOR #																

DET-1600 DETONATION SENSING MONITOR

FIGURE 6. WIRING DIAGRAM – POWER, INPUTS, AND OUTPUTS

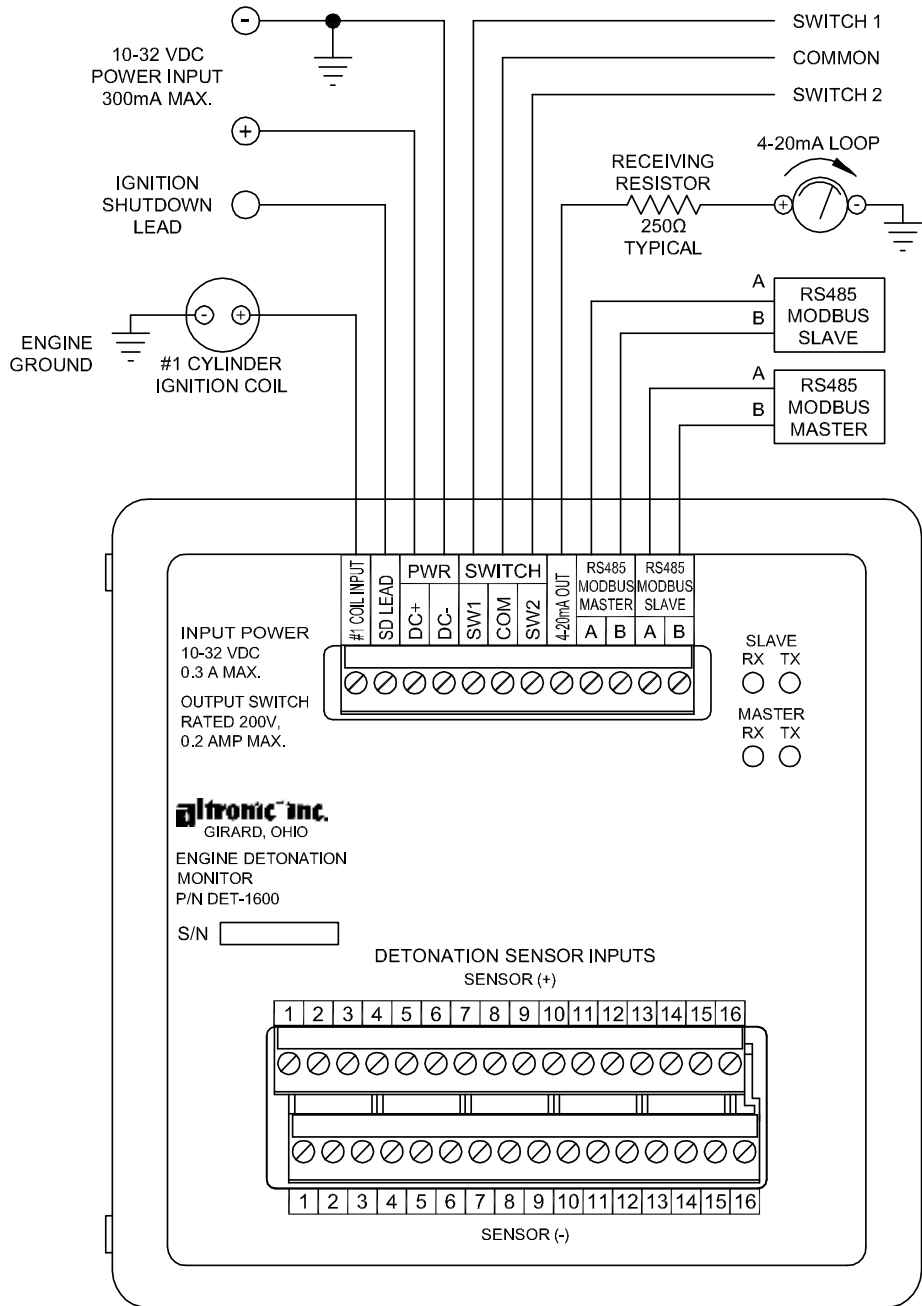

NOTES:

1. OUTPUT SWITCHES ARE RATED 200 VDC, 200 mA MAX. EACH SWITCH TURNS ON TO COMMON WHICH IS ISOLATED FROM DC -.
2. SWITCH 1 IS A CLOSED SWITCH WITH THE ABSENCE OF POWER AND IS TYPICALLY USED FOR LOAD CONTROL.
2. SWITCH 2 IS AN OPEN SWITCH WITH THE ABSENCE OF POWER AND IS TYPICALLY USED FOR SHUTDOWN.

FIGURE 7. WIRING DIAGRAM – MODBUS CONTROL TO IGNITION SYSTEM

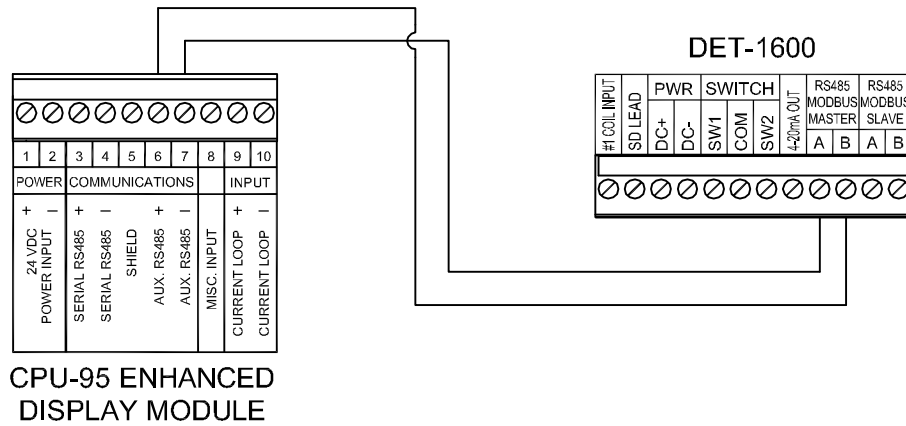

DET-1600/CD200

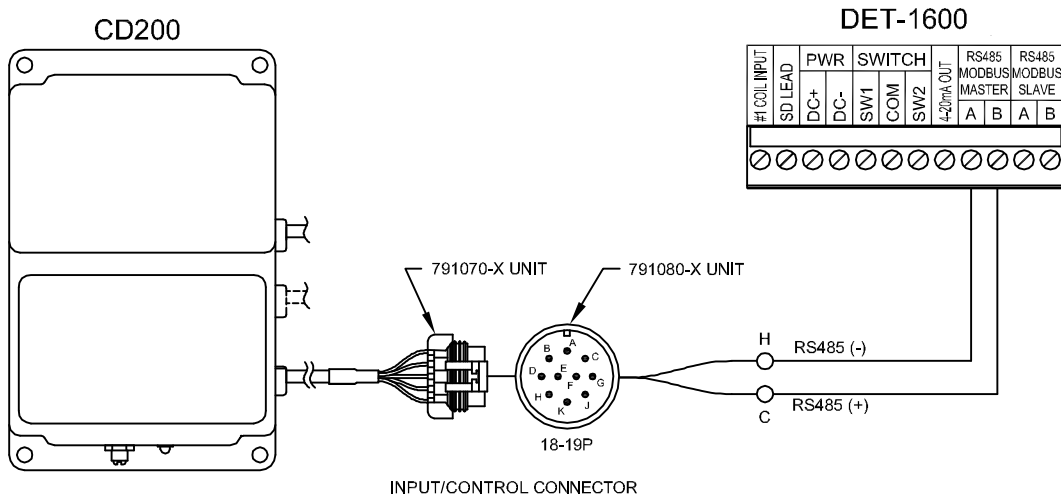

DET-1600 DETONATION SENSING MONITOR

FIGURE 8. WIRING DIAGRAM – CURRENT LOOP, CPU95

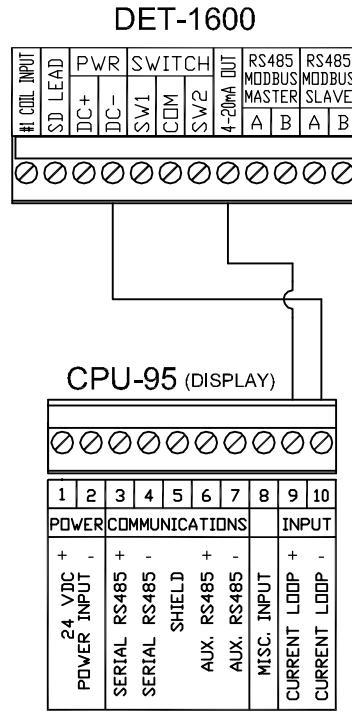

**DEGREES OF IGNITION RETARD
FROM MANUAL TIMING POSITION**

CPU-95 MEMORY CODE	CURRENT LOOP	
	4mA	20mA
A	0	48°
B	0	36°
C	0	24°
D	0	16°
E	0	8°

NOTE: THE DET-1600 4mA AND 20mA POINTS
MUST MATCH THE IGNITION SYSTEM
4mA AND 20mA POINTS.

FIGURE 9. WIRING DIAGRAM – CURRENT LOOP, CD200/DISN

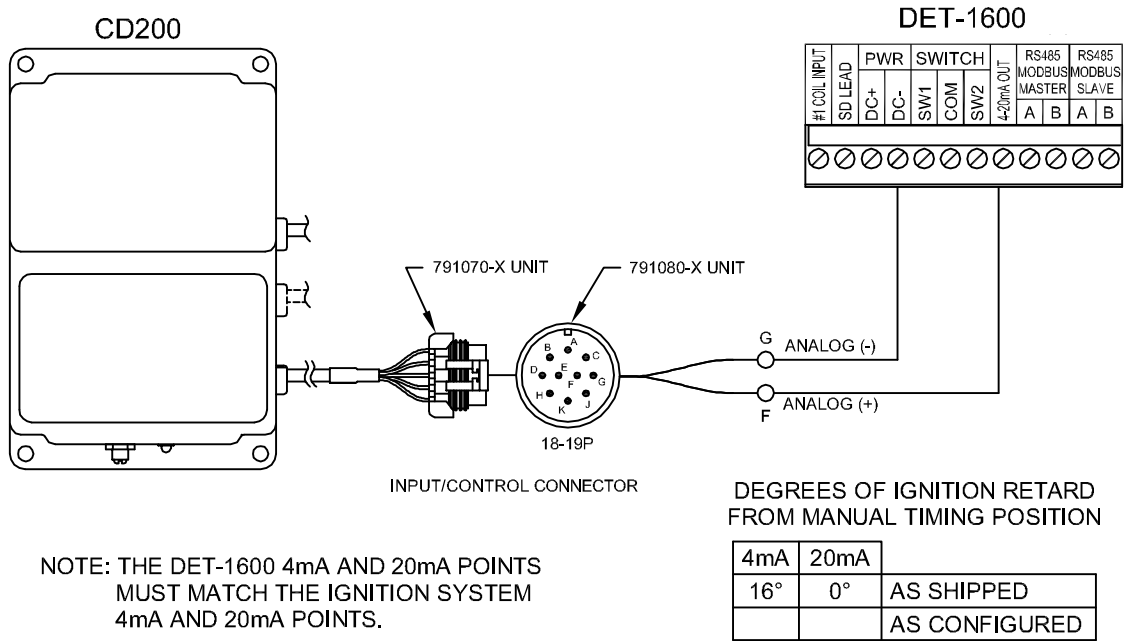

DET-1600/DISN

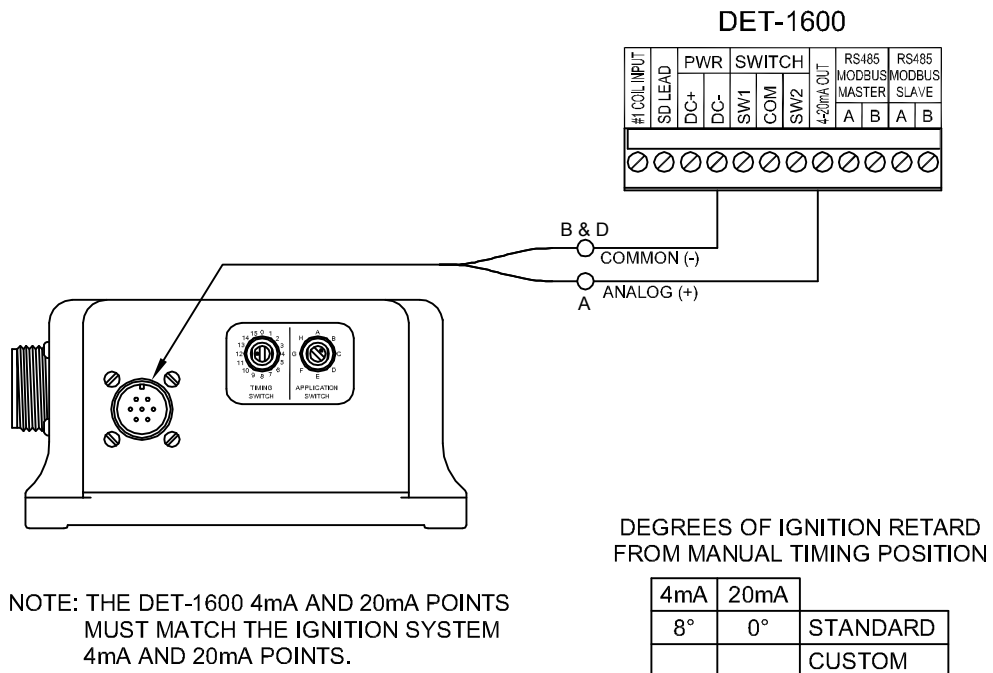

DET-1600 DETONATION SENSING MONITOR

FIGURE 10. WIRING DIAGRAM – ALTRONIC ANNUNCIATOR SYSTEMS

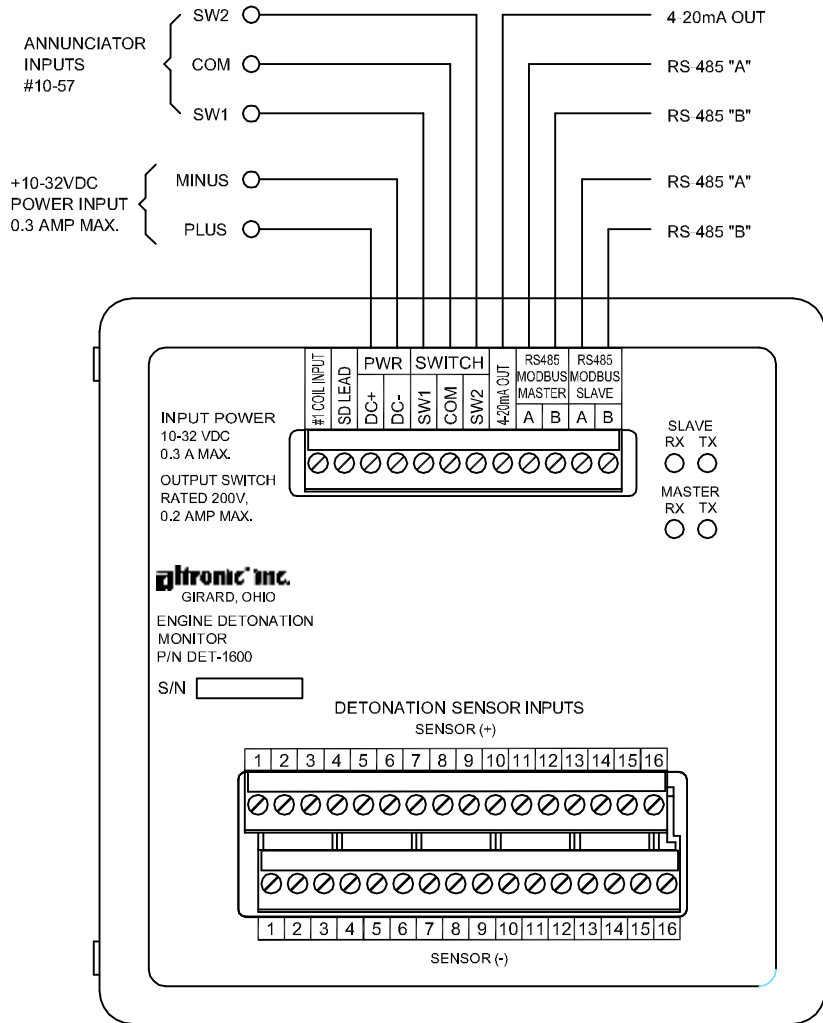
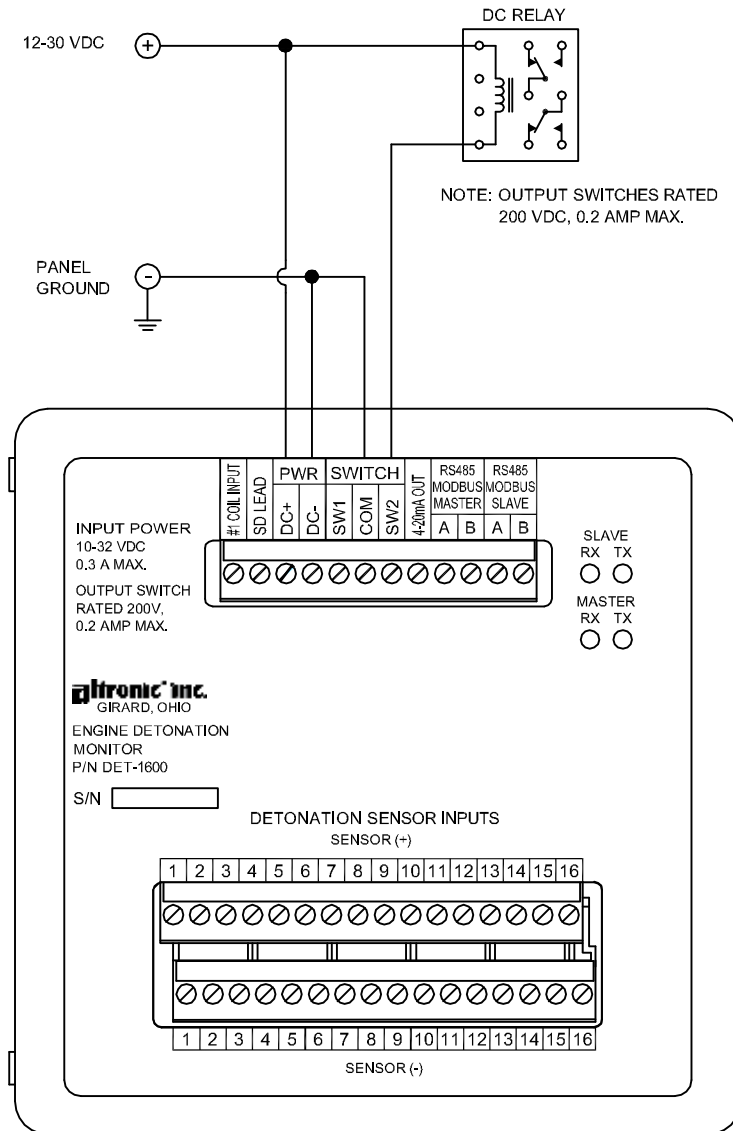
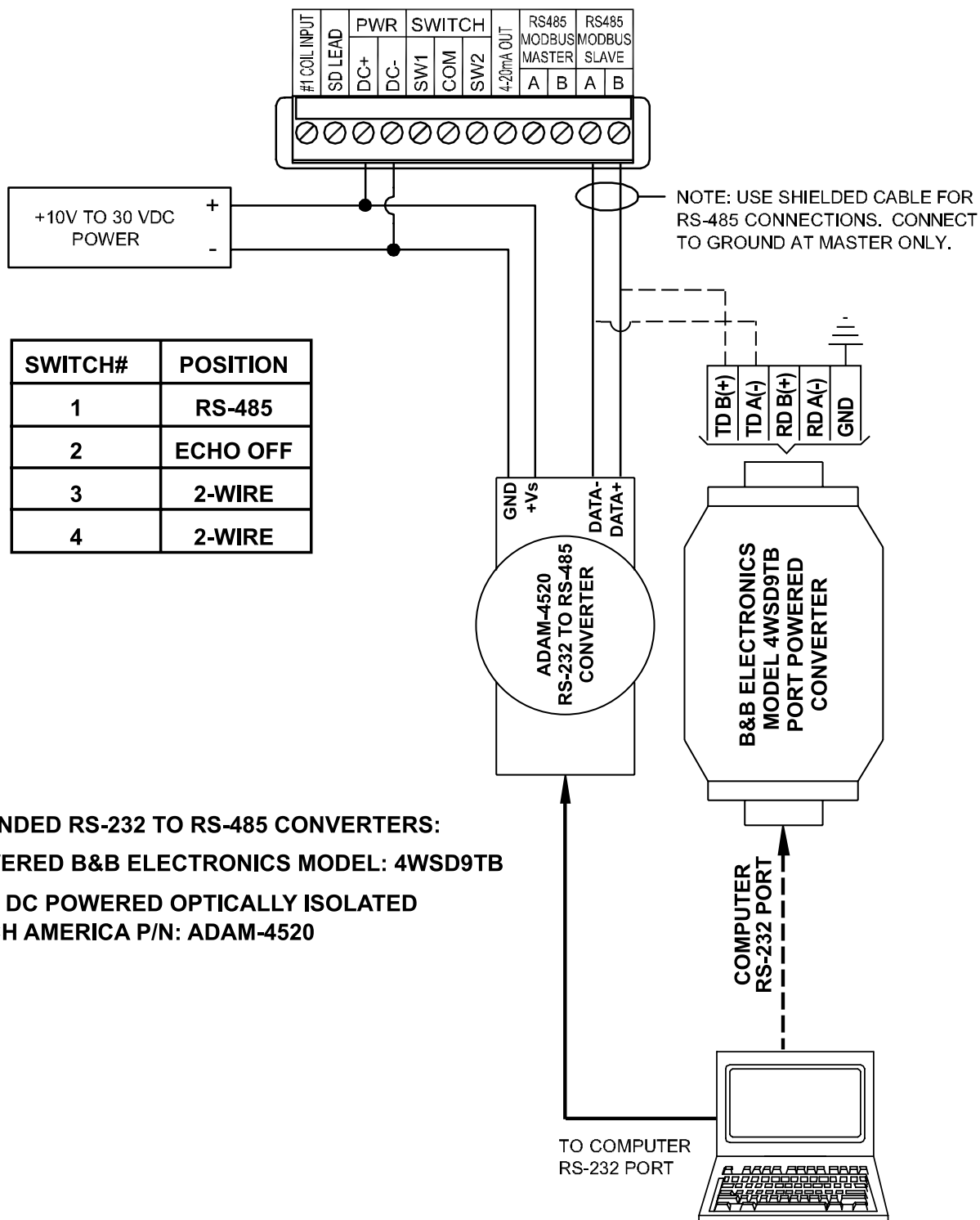

FIGURE 11. WIRING DIAGRAM – DC RELAYS



DET-1600 DETONATION SENSING MONITOR

FIGURE 12. WIRING DIAGRAM – RS-485 COMMUNICATIONS, PC HOOK-UP



RECOMMENDED RS-232 TO RS-485 CONVERTERS:
 PORT POWERED B&B ELECTRONICS MODEL: 4WSD9TB
 EXTERNAL DC POWERED OPTICALLY ISOLATED
 ADVANTECH AMERICA P/N: ADAM-4520